



**GLYNGARY**

Honouring Craft.  
Delivering Excellence.

# Honouring Craft.



# Delivering Excellence.



## Contents

---

Who we are	4
Our craft	6
Made In Britain	8
Established 1985	10
Why timber	14
The Signature Range	26
Materials	28
Colours	30
Our crafting techniques	34

---

Entrance doors	40
Hardwick Hardware	76
Anvil Hardware	96

---

Peace of mind guarantee	104
Quality control	106

---

CAD flush window	108
CAD stormproof window	112
CAD sash window	116
CAD entrance door	120
CAD french door	122
CAD sliding door	124
CAD bi-folding door	126
Options & Extras	128

---

Tailored products	130
Gallery	132

---

Our customers	144
Our process	146
Help sell and grow	148
Find an installer	150
Contact us	152

---



# Who we are

From our home in Cheshire, we've been proudly supplying hand-crafted wooden windows and doors to the trade since 1985. With decades of experience, our time served joiners craft each piece with passion and precision, knowing that our award-winning windows and doors are being installed in homes across Great Britain.

In recent years, we've seen a resurgence in the popularity of wooden windows and doors. More and more homeowners are recognising that timber is the superior choice for families who value sustainability, durability, energy efficiency, and long-lasting performance.

Scientific advances by the modified timber manufacturer Accoya have enhanced what can be achieved using timber. Accoya uses wood from fast-growing, responsibly managed forests, enhancing it through a unique acetylation process.

This process prevents the timber from absorbing water, dramatically improving its stability, durability, and energy efficiency—even in the face of Britain's ever-changing weather. Say goodbye to the warping, swelling, and distortion that often affects traditional timber products.

Not only does Accoya's timber offer superior performance, but it also stands as the most sustainable option on the market. Its wood comes from an infinite supply of responsibly managed forests, making it a far greener choice than hardwood, uPVC, or aluminium alternatives.

This is why we use Accoya as standard in our Signature range of hand-crafted windows and doors—because it offers the very best in sustainability, performance, and beauty.

 **See our workshop in action**



# Our craft

## You're in safe hands

We've been proudly supplying hand-crafted wooden windows and doors since 1985. It all started on this little saw, which we still hold in our workshop today as a reminder of where we came from.

We've come a long way, spending the last 40 years improving our joinery techniques, materials and machinery, whilst still honouring our traditions and craft.

This means after our products have been installed, homeowners can sit back and relax safe in the knowledge that their new windows and doors are the result of 40 years of hand-crafting excellence.

## Our beginnings

Glyngary was built on family values thorough the 80's, 90's and 00's by our founder, Colin Yates. He retired in 2017 and since then the business has been led by Colin's two sons Gary and Glyn, who have been involved in the family business since the 90's.

Today we operate from a 40,000 sq ft space in Cheshire. Our dedicated team includes time served joiners who've been part of our family for decades, as well as younger enthusiastic joiners who go through our testing apprenticeship scheme.



# Made In Britain

Everything we produce is designed, manufactured and finished right here in our Cheshire workshop, UK. We believe that makes all the difference - not just for us, but for the installers, house builders, re-sellers and homeowners who choose our products.

## Our workshop

The ultimate selling tool

Having a manufacturing facility here in the UK allows us to do something a lot of companies can't - invite people in. Our customers can allow their customers to visit the workshop before they place an order.

It's an opportunity to look, touch, smell and experience the product first-hand - to see our team at work, crafting each frame and sash with care. That visit alone often seals the deal. There's something powerful about standing where the product is made and meeting the time served joiners who work the magic.

## Tested, trusted, compliant

UK building regulations are constantly evolving, and rightly so. From U-values to PAS24 security standards, our windows and doors are manufactured to meet - and exceed - what the UK market demands.

When homeowners buy British, they're not just investing in a product that looks good - they're investing in compliance, performance, durability, and peace of mind.

## Investing in people, not just products

When you buy from a UK manufacturer, you're supporting more than just a business. You're contributing to a skills-based economy. Every year we take on young apprentices eager to learn the trade.

We invest in their development, teaching them lifelong skills in joinery, machining, finishing and craftsmanship - trades that are vital to the future of UK manufacturing.

Buying British helps ensure those opportunities continue to exist. It keeps knowledge in the country and fosters innovation where it's most needed - on the factory floor.

## Ethical, transparent, responsible

When you buy from a British manufacturer, you can be confident that the product you've purchased have been made under fair working conditions and ethical employment practices governed by UK law.

This transparency matters - especially for consumers who want the reassurance that products they will use for decades have been made with love and care by skilled professionals who are treated fairly.

## Sustainability by design

Sustainability isn't just about what your windows are made from - it's about how far they've travelled, and how they were made. By choosing products that are manufactured locally, you reduce the carbon footprint associated with long-distance freight.

Timber is already one of the most environmentally responsible materials in construction, and sourcing it through a UK-based manufacturer keeps its sustainability credentials intact.

## Customer service you can count on

Sometimes, despite our best efforts, things don't go exactly to plan. Maybe there's a specification change, or an issue onsite.

When that happens, being able to speak to someone directly - in your time zone, with shared language and cultural understanding - makes a huge difference. UK-based customer service isn't just convenient - it's effective, relatable, and reliable.



# Established 1985

In June 2025 we celebrated our 40th birthday, standing proud with 4 decades of uninterrupted trading in the UK, through this time keeping the same name, the same company registration number and the same passion for what we do.

Despite the turbulence of our economy over this time, our consistently high-quality hand-crafted products, personalised service, and passion for constant improvement & innovation has guided us through and retained our loyal customer base.

Today our workforce of 20+ bench joiners includes a range of wonderful personalities who we are very lucky to have, ranging from some of the very originals now approaching retirement, to our young and enthusiastic apprentices who are learning the craft.



## CERTIFICATE OF INCORPORATION OF A PRIVATE LIMITED COMPANY

No. 1920480

I hereby certify that

**GLYNGARY JOINERY LIMITED**

is this day incorporated under the Companies Acts 1948 to 1981 as  
a private company and that the Company is limited.

Given under my hand at the Companies Registration Office,  
Cardiff the

7TH JUNE 1985

*D. G. Blackstock*

**D. G. BLACKSTOCK**  
an authorised officer



# Why timber

---

## Sustainability

---

Did you know that 43% of uPVC is derived from petroleum, a finite resource that contributes significantly to the world's carbon dioxide emissions?

In the face of a climate emergency, the need for sustainable, renewable, and fully recyclable building materials has never been more urgent.

By choosing windows and doors crafted from FSC-certified timber, you're supporting responsibly managed forests that maintain a constant, renewable cycle of supply. Trees naturally absorb around 25% of the carbon emissions produced by human activity. However, as they age, their ability to capture carbon decreases, so at this point, they're transformed into Accoya, making room for new, fast-growing trees that can take up the carbon-absorbing role.

Accoya is not just an environmentally friendly choice—it's a groundbreaking one. It's the only construction material worldwide to earn Cradle to Cradle (C2C) Platinum certification® for Material Health.

With its low carbon footprint, choosing Accoya windows and doors means your family is actively helping to reduce carbon emissions, contributing to a healthier planet.

We are committed to sustainability in every step of our process. In 2016, we invested in a biomass boiler heating system, which heats our workshop and paint drying booths using our own timber offcuts rather than gas. This is just one example of how we're reducing our environmental impact.

With a lifespan of over 70 years and fully recyclable at the end of their lifecycle, our hand-crafted windows and doors offer an unparalleled level of sustainability.

From the sourcing of materials to production and delivery, they are the ideal choice for families looking to make a positive difference in the face of today's environmental challenges.



## Longevity

---

Hand-crafted wooden windows and doors are the result of skilled craftsmanship, not mass production. Each piece is meticulously created by professional, time-served joiners.

Every mortice and tenon joint, coat of paint, and decorative moulding requires time and expertise to perfect. As a result, the initial cost of wooden windows and doors may be higher than uPVC or aluminium alternatives.

However, the true value of our windows and doors lies in their longevity. With a life expectancy of over 70 years, they far outlast alternatives like uPVC, which typically last just 15–20 years.

Unlike uPVC or aluminium, which can start to look worn out over time with no easy way to refresh them, our timber windows and doors can be repainted to look like new, year after year.

As trends evolve, children grow up, and homes are redecorated, your windows and doors can evolve with you.

Repainting not only restores your windows and doors to their original beauty but also allows them to blend seamlessly with new decor styles.

From the moment they're installed, our Accoya high-performance windows and doors start paying for themselves—delivering long-lasting value, timeless appeal, and unmatched durability.



## Durability

---

Our windows and doors offer outstanding resistance to insect attacks and damage. Thanks to Accoya's unique properties, it's indigestible to a wide range of pests, including termites, creating a natural, highly effective barrier against infestations.

Plus, Accoya's exceptional stability means there's minimal risk of issues during assembly, installation, or in the years to come.

Accoya sets a new standard for timber reliability. After undergoing the advanced acetylation process, it is rigorously checked and trusted not to swell, shrink, or distort. With only minimal movement, it remains highly durable, enduring the harshest climates for an impressive lifespan of 70+ years.

Our windows and doors are crafted to be structurally sound, using traditional joinery techniques honed over four decades.

Combined with our dedication to sourcing only the finest materials, we create hand-finished products that are designed to perform seamlessly through both winter and summer, year after year.

## Energy efficiency

---

With rising costs and a growing energy crisis, energy efficiency has become a top priority for homeowners choosing new windows and doors.

Whilst uPVC and aluminium systems are constantly being modified and adapted just to meet the UK's increasingly stringent energy performance regulations, timber stands apart as a natural insulator, boasting low thermal transmittance and helping to retain warmth whilst keeping the cold out.

By combining Accoya timber with high-performance, energy-efficient glass, our Signature range achieves industry-leading U-values. Our double-glazed windows and doors deliver a U-value of 1.2 W/m<sup>2</sup>K, outperforming current UK regulations by 15%.

With triple glazing, the U-value can be as low as 0.68 W/m<sup>2</sup>K – an impressive 52% better than current standards. All our U-value testing and declarations adhere to BR442 guidelines and the EN 14351-1 standard, ensuring exceptional energy performance.



## What is Accoya?

Accoya is not a tree species, it's radiata pine that has been chemically modified to improve its performance.

## How is it modified?

The modification process, called acetylation, involves treating the wood with acetic anhydride (a component of vinegar). This process alters the wood's cellular structure, making it more resistant to moisture and decay.

## The benefits:

This modification results in a wood that is highly durable, dimensionally stable, and resistant to rot and insects. Accoya is the perfect product for windows and doors, but it's also trusted worldwide on projects that test its claims, showcasing its beauty, versatility and durability...



**DIMENSIONALLY STABLE**



**MINIMAL MAINTENANCE**



**NON TOXIC**



**SUSTAINABLY SOURCED**



**RETAINED STRENGTH AND DENSITY**



	Accoya	uPVC	Aluminum
Durability	Very high - (25 year guarantee and 70+ year life)	Moderate - (can become brittle over time)	High - (resistant to corrosion if coated)
Stability	Excellent - doesn't warp or swell	Good - but can warp in extreme heat	Excellent
Maintenance	Low - holds paint well, fewer repaints	Very low - doesn't require painting	Low - may need repainting if powder coat wears off
Insulation	Very high - natural thermal insulator	Average - if uPVC reinforcement is used instead of steel	Poor - unless thermally broken
Aesthetic	High-end natural wood look	Plastic appearance	Sleek, modern, but cold looking
Sustainability	Very sustainable - FSC wood, non-toxic	Low - made from fossil fuels, not recyclable	Moderate - recyclable but energy intensive to make
Cost	Higher upfront, long-term value	Low upfront cost	Medium to high - depending on design
Lifespan	70+ years	20-30 years	30-45 years (with good care)
Customizability	Very adaptable, easily shaped to any project.	Limited colours and section sizes available	Limited colours and section sizes available
Environmental Impact	Very low - (eco-friendly process)	High - (non-biodegradable, landfill issues)	Moderate - (can be recycled)

# Accoya case studies

---

## The Moses Bridge

Netherlands

The West Brabant Water Line is an early 17th century Dutch defensive line, created by linking towns with fortresses and walls. As part of a recent restoration programme, the largest fort required an access bridge. The fort is surrounded by a moat and was originally built without a bridge so it was a challenge to create one that would be discreet.

The solution was to build a 'sunken' bridge that sits almost at the level of the water, making it practically invisible as you approach the fort. The bridge is built from Accoya wood sheet piling on either side, with a hardwood deck/stairs in between. Accoya wood's durability and guaranteed performance in-ground and in freshwater made this possible.

## The Royal Arena

Copenhagen

The Royal Arena in Copenhagen, was designed to host a variety of international arts and sporting events. Durability and aesthetic appeal were key considerations in its design, leading to the selection of Accoya as the ideal material.

Approximately 250 cubic meters of Accoya were used for the arena's entire façade. The arena seats 12,500 people, with additional standing capacity for 15,000. Accoya was chosen not only for its durability but also for meeting global environmental standards. The project architects (3XN), known for their commitment to sustainable development, found Accoya to be a perfect fit.

## Bangaroo House

Sydney

Barangaroo House, a free-standing, three-storey restaurant, has become one of the first projects in Sydney to utilise Accoya wood cladding and the Japanese charring technique, Shou Sugi Ban.

Inspired by the potential of creating a building in the round, the unique split level restaurant was designed by architects, Collins and Turner, taking on a remarkable organic form clad in charred Accoya®. Around 45mm of Dowelled Accoya and 45mm of Half Dowelled Accoya® were laminated into a series of predetermined radii with a Shou Sugi Ban finish applied to create a striking charcoal appearance.





# The Signature Range

## Flush window

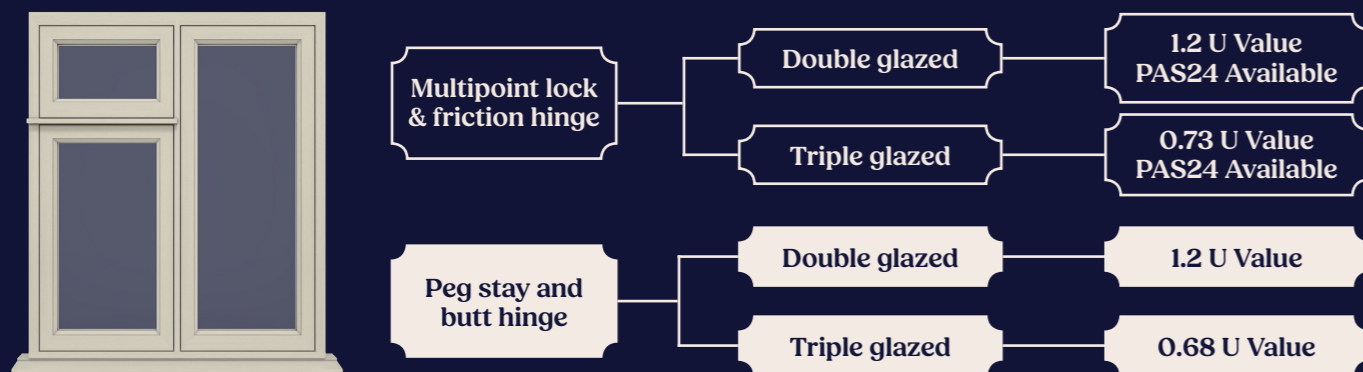

## Stormproof window

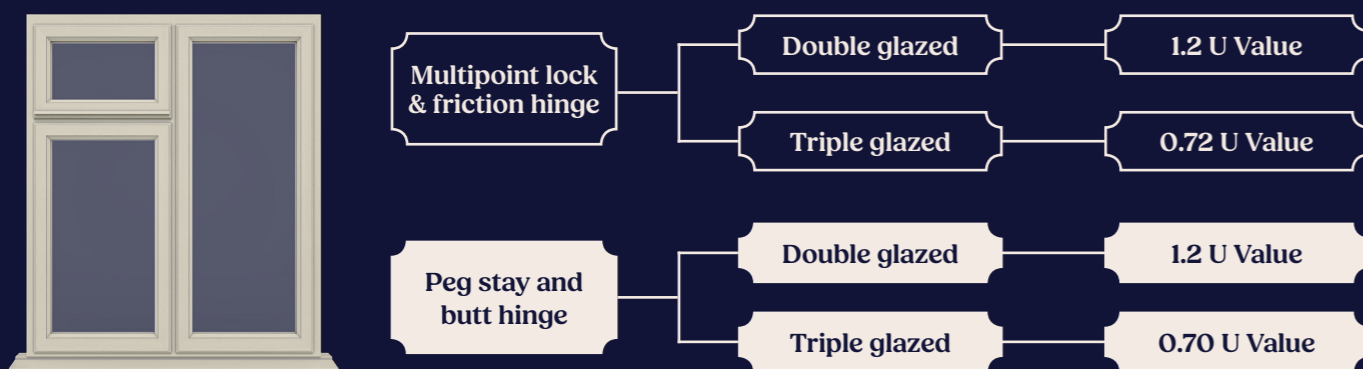

## Sash window

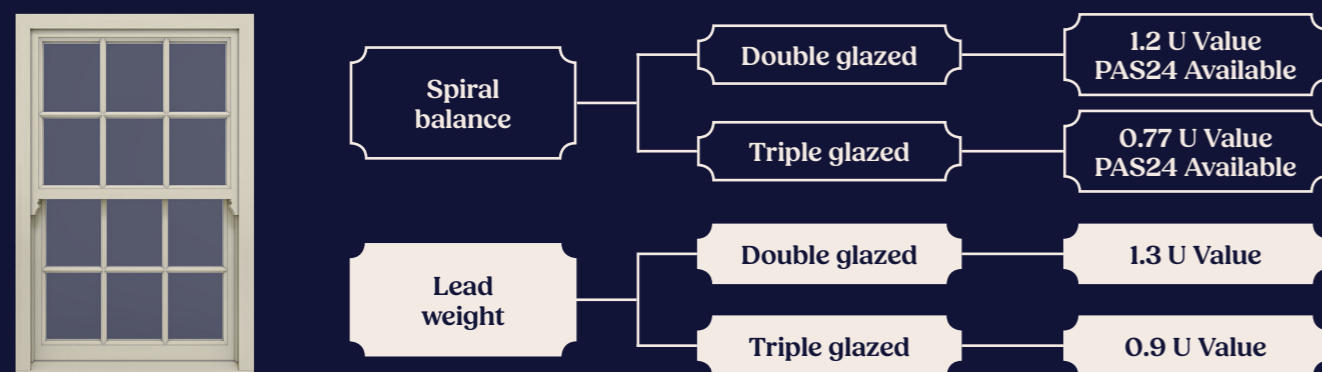

## Entrance door



## French door



## Sliding door



## Bi-fold door



# Materials

## Timber

We use Accoya as standard on our Signature range of windows and doors because we believe it's the best material available.

If requested, as part of our Tailored range we can also create windows and doors in a range of hardwood options.



GUARANTEE

## Hardware

We are proud to offer two premium hardware ranges from UK based suppliers Hardwick and From The Anvil.

Our Hardwick range is fitted as standard, and the beautiful Anvil range is available as an upgrade. We can also fit bespoke hardware selected by you, from any supplier.



GUARANTEE



## Glass

Our energy performance glass comes from the UK's premium glass manufacturer System 3, who are based locally in Manchester.

We can also supply our window & doors with PassivGlas Vacuum Glazing, achieving unmatched thermal performance & noise reduction.



GUARANTEE

## Paint

Our paint comes from leading supplier Teknos, who have been producing in Finland since 1948. Teknos have been working in collaboration with Accoya since 2008, ensuring a perfect combination for a long-lasting finish. All our windows and doors are triple coated in our dedicated paint shop before leaving our workshop.



GUARANTEE



# Colours



Our paint comes from leading supplier Teknos, who have been producing it since 1948.

Teknos have been working in collaboration with Accoya since 2008, making it the perfect combination for a long-lasting finish.

All our windows and doors receive a three-coat professional spray finish before leaving our workshop. We can match any RAL or Farrow & Ball colour, and we can dual-colour, giving a different appearance inside and outside.

Below are some of our most popular colours:





# Our crafting techniques

## Seamless corners

Mass-produced timber manufacturers that focus on speed can often be identified by their use of shadow grooves on the frame and sash corner joints. Shadow grooves are used regularly because they hide corners that are not perfectly flush fitting. Decades of bench joinery experience enables us to achieve mortice and tenon corner joints that are seamless, flush and almost invisible.

We finish them flush because we proudly enjoy having nowhere to hide. Our corners are perfect every time.



## Flush-fit, colour matched trickle vents

Trickle vents are ugly, but ours are made from aluminium, not plastic. They boast a flush finish inside and out, with the outside grille being virtually hidden by our head drip when fitted in the outer frame. We paint our vents, so they are an identical match to the colour of the frame.

\*Flush vent externally is only available in outer frame and head drip must be fitted.



## Multipoint lock & egress as standard

We fit multipoint locking as standard, and egress escape hinges on all side openers as standard. As well as effortlessly complying with fire escape regulations if sash widths allow, egress hinges provide a traditional timber look, with the sash swinging open from the corner. Butt hinges with peg stays are also available.



## Sash windows with options

We proudly offer 5 sash horn designs, as well as 4 staff bead options, 4 outside lining options and 3 external glazing bead options. This allows our sash windows to fit in with any type of property. Our sash horns are hand finished using our precision bandsaw and oscillating spindle sander.

In addition, we can offer any bespoke shape of sash horn to match existing windows as part of our Tailored range, from a template or detailed drawing.



## Accoya all through

We don't cut corners on product quality to save money.

Cheaper, plastic based beads & astragal bars are often used on timber windows & doors in the UK to save money. However, we can proudly say that when Accoya is ordered, we use it on every part of the window including beads and bars, providing the peace of mind 25-year guarantee that we stand to.

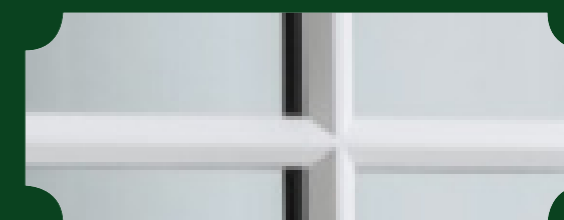

# Our crafting techniques

## Three-coat, dual colour paint

We apply a three-coat professional spray finish to all our windows and doors, ensuring a perfectly consistent finish every time. Each coat contains 120-150 microns of paint, which is the equivalent of 10 brush coats. We can match any RAL or Farrow & Ball colour, and we can dual colour, giving a different appearance to the inside and outside of the home.



## Externally beaded, glass sealed

Our windows and doors are externally beaded, which gives them the traditional look they deserve. Our glass is security taped in place meaning it cannot be removed from the outside by unwanted intruders. External beading not only looks better, but it also eliminates the risk of water building up in the rebate channel, which can inevitably work its way through an internal bead into the home causing damage to internal surfaces.



## Twin mortice and tenon sash joint

Over four decades we've perfected our corner joints. On window sashes we take extra time to craft twin mortice and tenon joints, as standard, combined with star dowel fixing.

This traditional method ensures every corner leaves our workshop strong, secure, and ready to last for a lifetime of operation.





# Entrance doors

Our range of 30 solid timber entrance doors have been carefully selected to compliment many different property styles.

To finish, we have a wide selection of decorative glass designs and hardware options available.

Because we use traditional joinery techniques, we can also cater for bespoke needs whether this be a unique door design, personalised glass or outsourced hardware.

**1.2**  
W/km<sup>2</sup>K

Double Glazed  
U-Value

**0.72**  
W/km<sup>2</sup>K

Triple Glazed  
U-Value

**PAS24**

Available

## Our entrance door styles



**Didsbury**



**Knutsford**



**Wilmslow**



**Bowden Solid**



**Bowden 2 Glass**

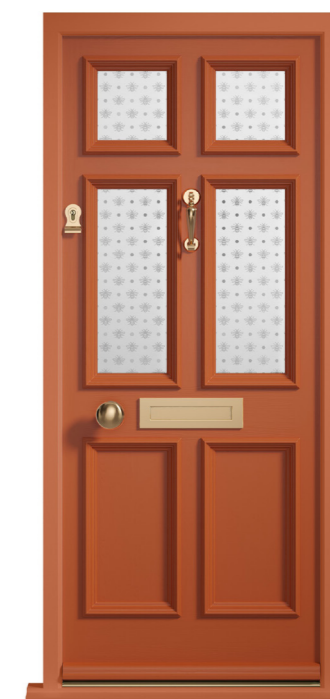

**Bowden 4 Glass**

# Our entrance door styles



**Bramhall**



**Ashley**



**Alderly**



**Whalley Solid**



**Whalley 2 Glass**

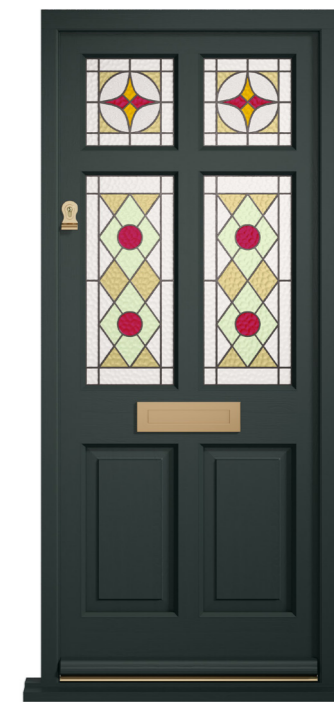

**Whalley 4 Glass**



**Northwich 4 Glass**



**Northwich Solid**



**Northwich 2 Glass**



**Heaton**



**Downham**



**Cartmel**

# Our entrance door styles

---



**York**

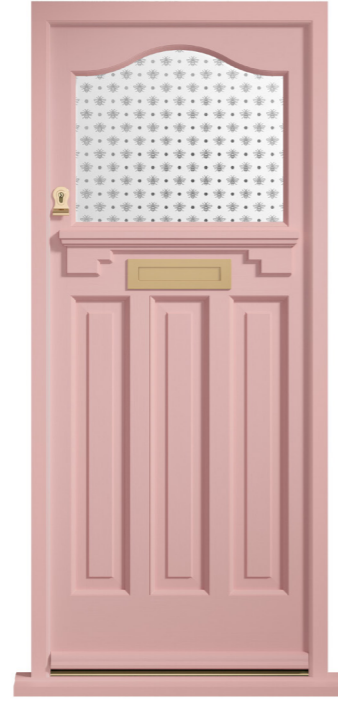

**Marple**



**Hale**



**Chester**



**Whitby**



**Mere**



**Tatton**



**Prestwich**



**Eaton**



**Bakewell**

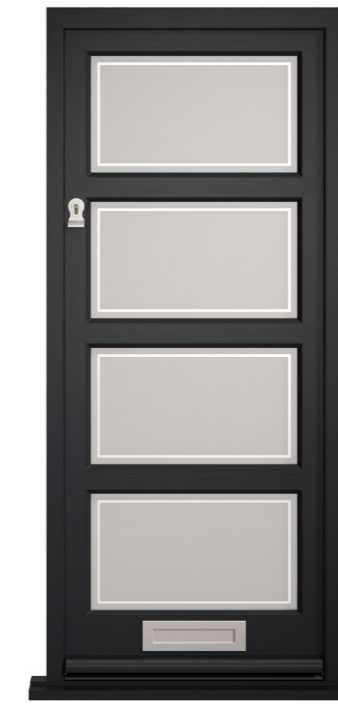

**Dunham**



**Chorlton**

# Entrance door designs

**1** Select door style:



• Disbury •



• Knutsford •



• Bramhall •

# Decorative glazing options

**2** Select corresponding glass:



Kensington



Victorian Boarder



Mayfair

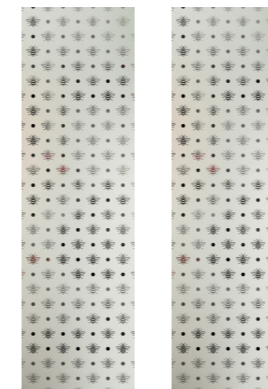

Worker Bee

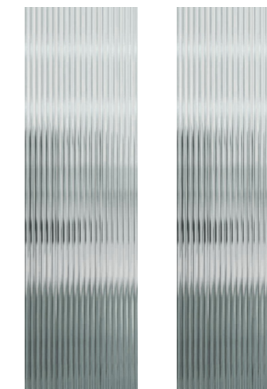

Fluted

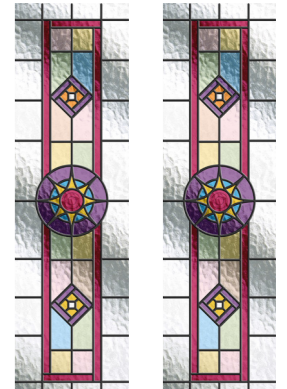

Artle

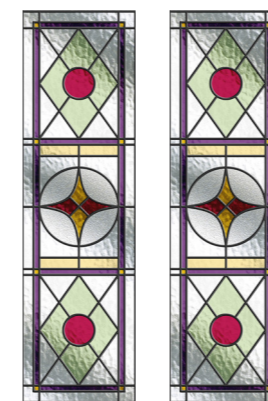

Irwell

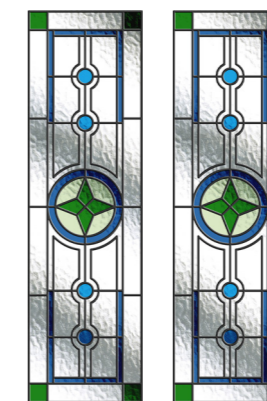

Etherow

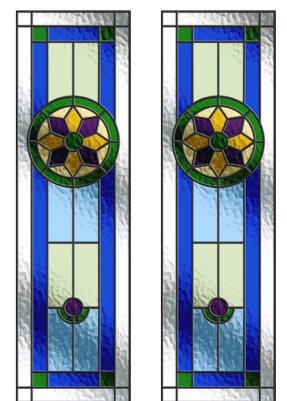

Weaver

# Entrance door designs

**1** Select door style:



• Bowden 2 Glass •

• Whalley 2 Glass •

• Northwich 2 Glass •



• Bowden 4 Glass •

• Whalley 4 Glass •

• Northwich 4 Glass •

# Decorative glazing options

**2** Select corresponding glass:



Kensington



Victorian Boarder

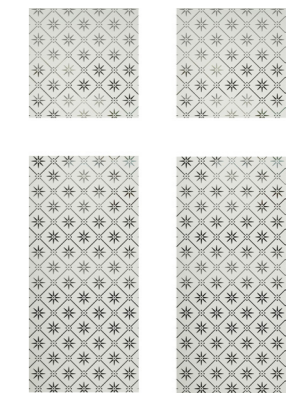

Mayfair

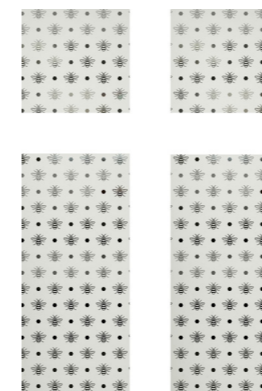

Worker Bee

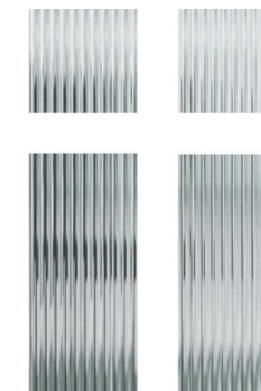

Fluted

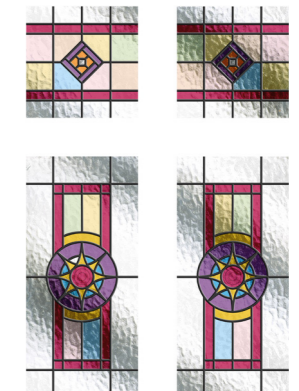

Artle

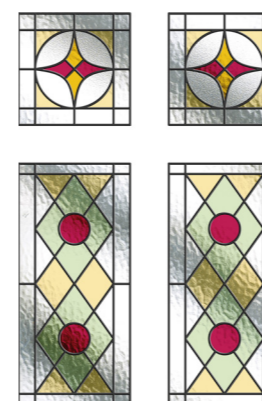

Irwell

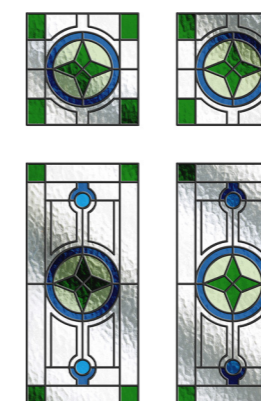

Etherow

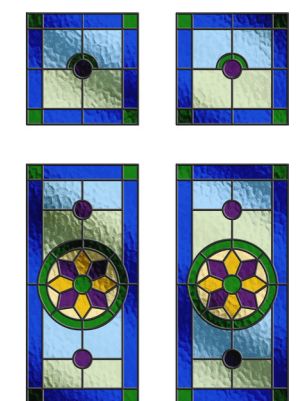

Weaver

# Entrance door designs

1 Select door style:



• Wilmslow •

# Decorative glazing options

2 Select corresponding glass:



Kensington



Victorian Boarder



Mayfair

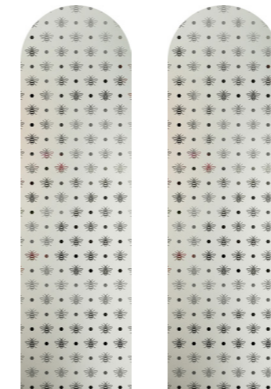

Worker Bee

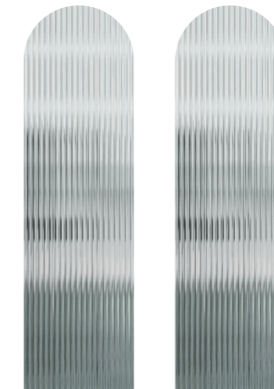

Fluted

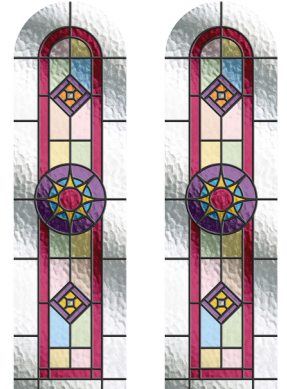

Artle



Irwell

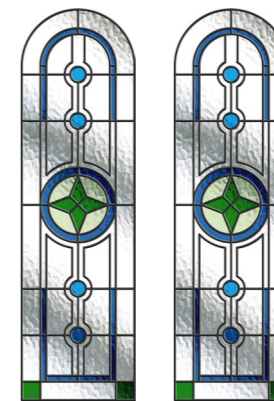

Etherow

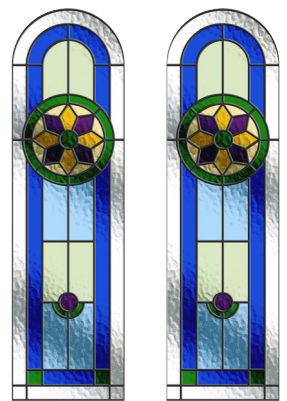

Weaver

# Entrance door designs

**1** Select door style:



• Prestwich •



• Tatton •



• Mere •

# Decorative glazing options

**2** Select corresponding glass:



Kensington



Victorian Boarder

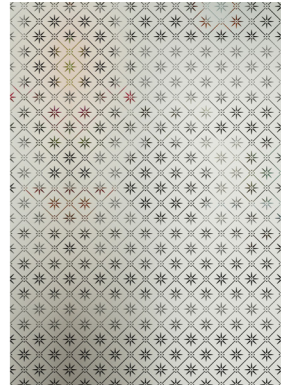

Mayfair

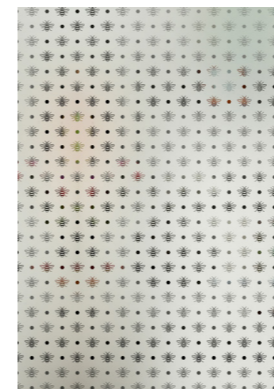

Worker Bee



Fluted



Letters and Numbers

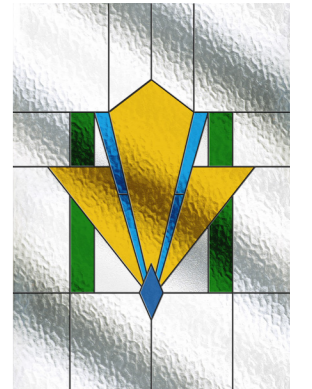

Eagley

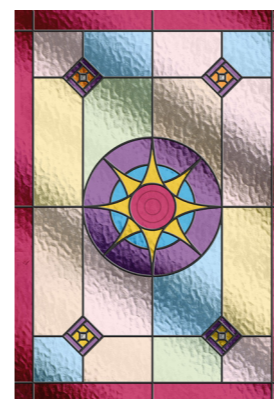

Artle

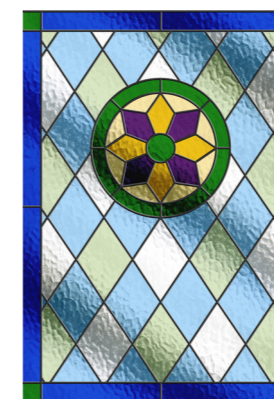

Weaver

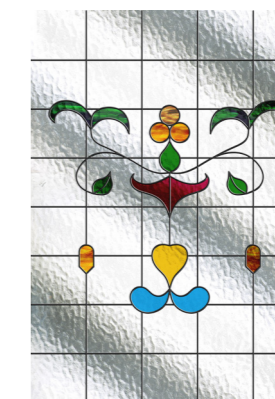

Mersey

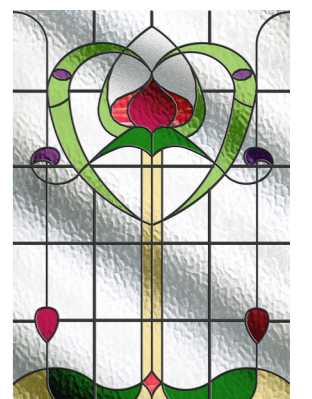

Bradshaw

# Entrance door designs

1 Select door style:



• Eaton •

# Decorative glazing options

2 Select corresponding glass:



Kensington



Victorian Boarder



Mayfair

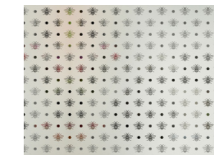

Worker Bee

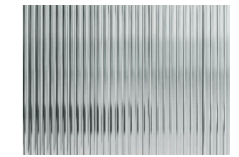

Fluted



Letter and Numbers

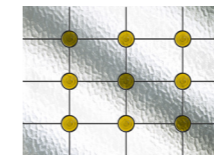

Douglas Yellow

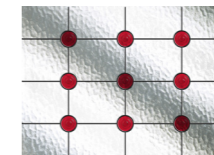

Douglas Red

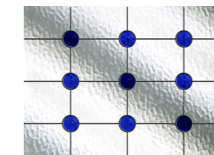

Douglas Blue

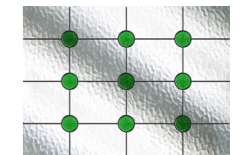

Douglas Green

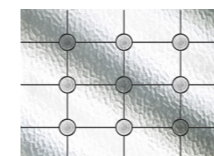

Douglas Clear

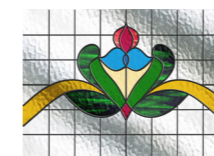

Roeburn



Bradshaw

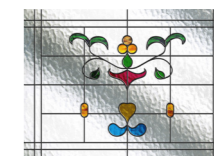

Mersey



Eagley

# Entrance door designs

**1** Select door style:

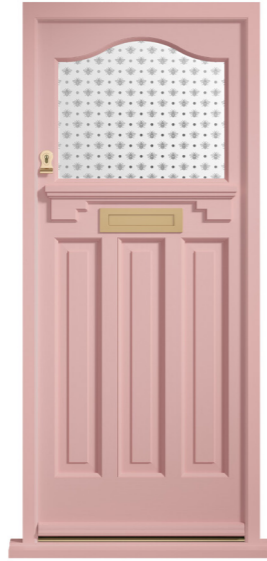

• Marple •



• Downham •

# Decorative glazing options

**2** Select corresponding glass:



Kensington



Victorian Boarder



Mayfair

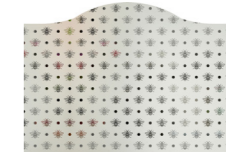

Worker Bee

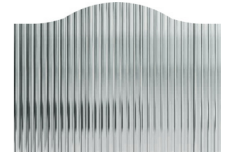

Fluted



Letter and Numbers

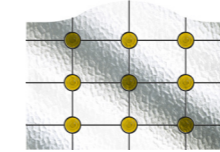

Douglas Yellow

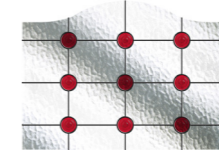

Douglas Red

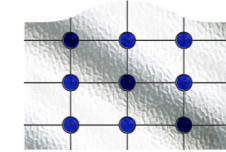

Douglas Blue

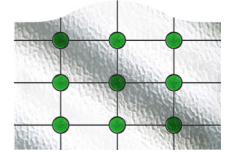

Douglas Green

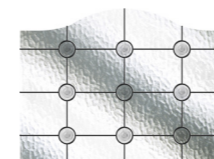

Douglas Clear



Roeburn

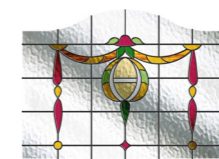

Bradshaw

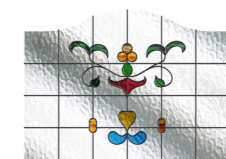

Mersey



Eagley

# Entrance door designs

1 Select door style:



• Cartmel •

# Decorative glazing options

2 Select corresponding glass:



Kensington



Victorian Boarder



Mayfair

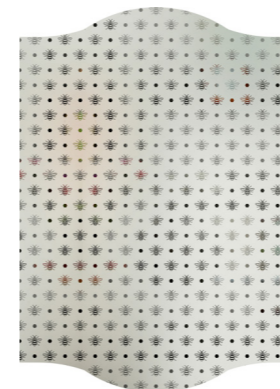

Worker Bee

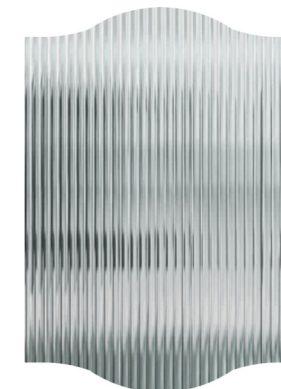

Fluted



Letters and Numbers

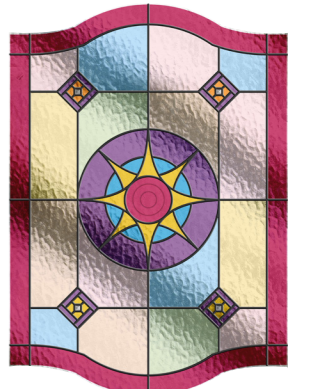

Artle

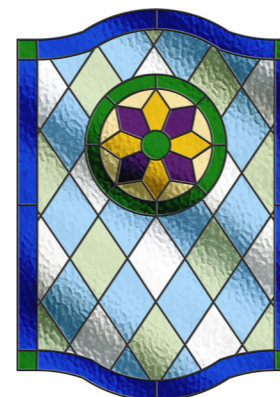

Weaver

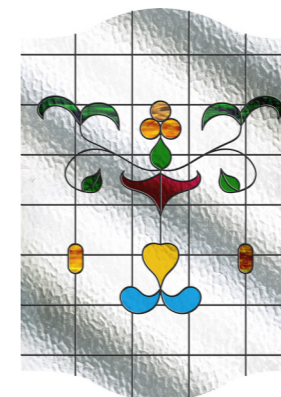

Mersey

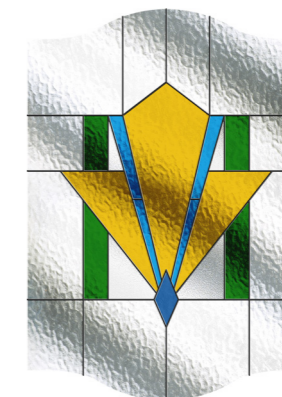

Eagley

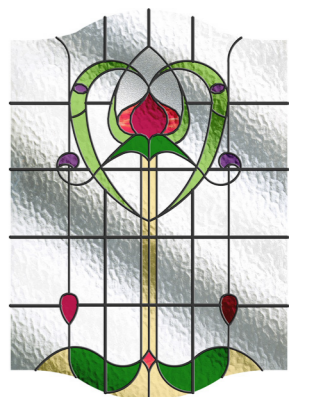

Bradshaw

# Entrance door designs

1 Select door style:



• Ashley •

# Decorative glazing options

2 Select corresponding glass:



Kensington



Victorian Boarder



Mayfair

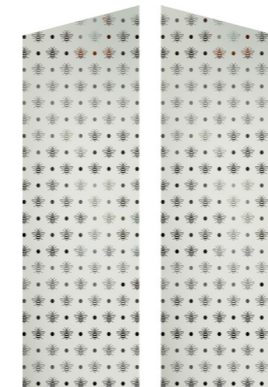

Worker Bee

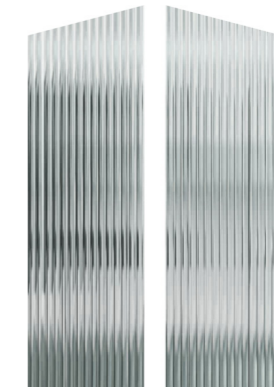

Fluted

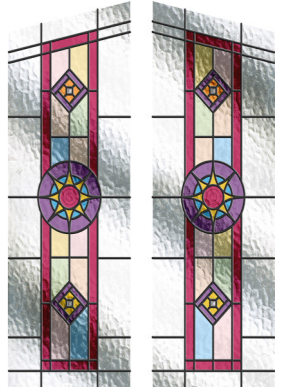

Artle



Irwell

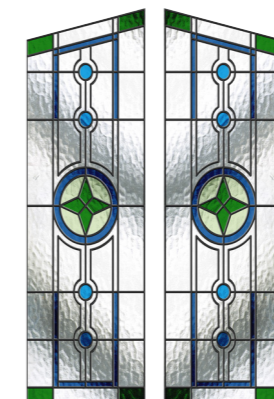

Etherow

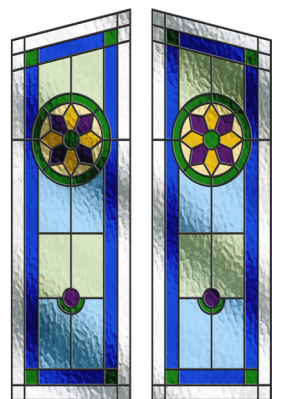

Weaver

# Entrance door designs

1 Select door style:



• Heaton •

# Decorative glazing options

2 Select corresponding glass:



Kensington



Victorian Boarder



Mayfair

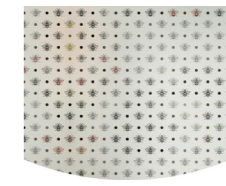

Worker Bee

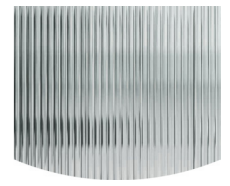

Fluted



Letter and Numbers

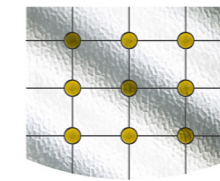

Douglas Yellow

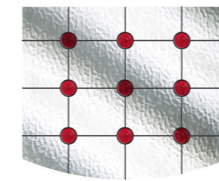

Douglas Red

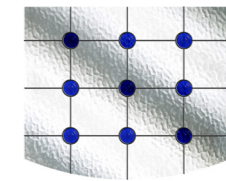

Douglas Blue

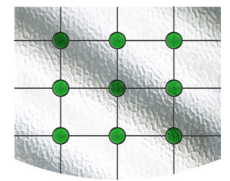

Douglas Green

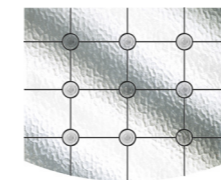

Douglas Clear



Roeburn

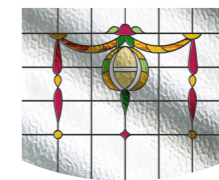

Bradshaw

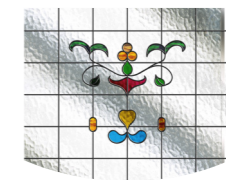

Mersey



Eagley

# Entrance door designs

1 Select door style:



• Alderly •

# Decorative glazing options

2 Select corresponding glass:



Kensington



Victorian Boarder



Mayfair

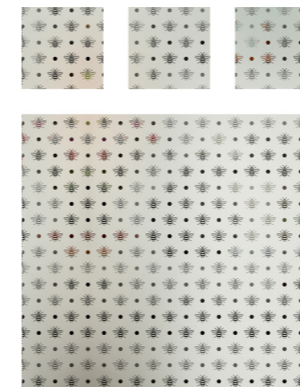

Worker Bee

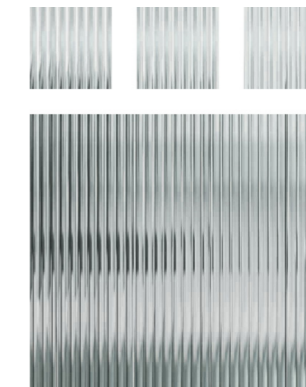

Fluted

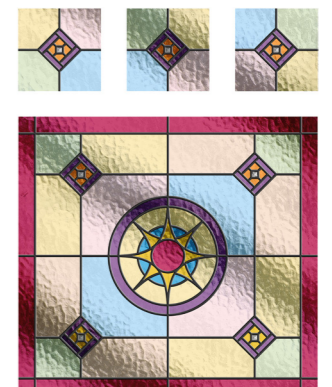

Artle

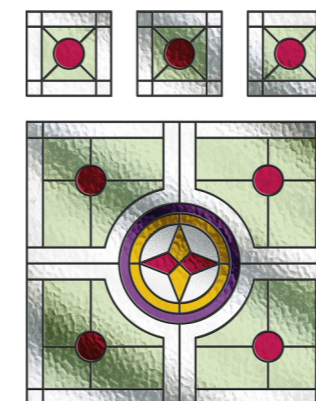

Irwell

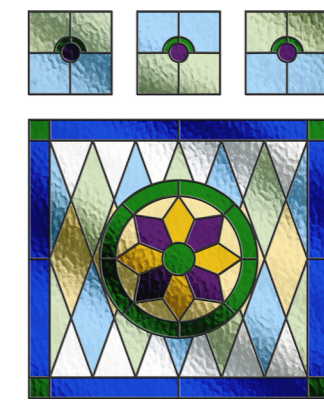

Weaver

# Entrance door designs

1 Select door style:



• Hale •

# Decorative glazing options

2 Select corresponding glass:



Kensington



Mayfair

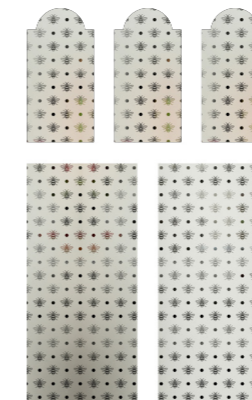

Worker Bee

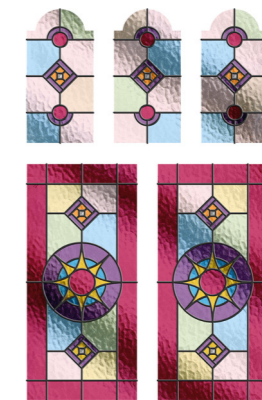

Artle

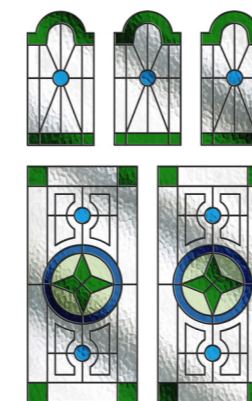

Etherow

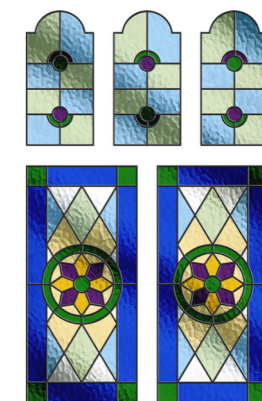

Weaver

# Entrance door designs

1 Select door style:



• York •

# Decorative glazing options

2 Select corresponding glass:



Kensington



Letters and Numbers

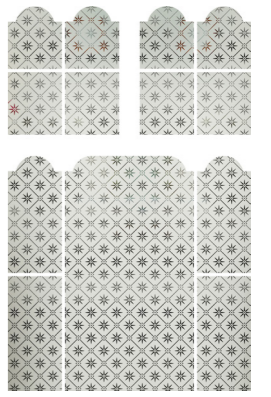

Mayfair

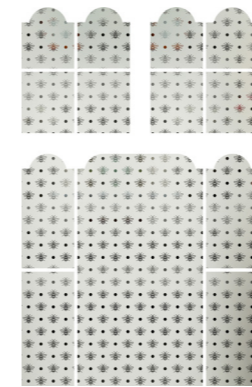

Worker Bee

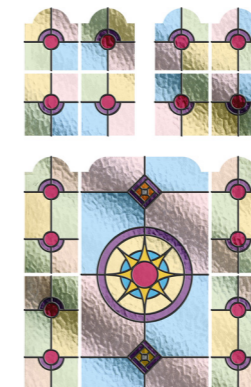

Artle

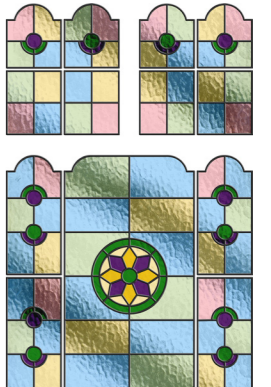

Weaver

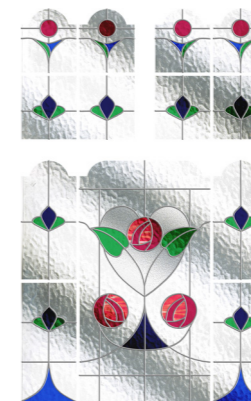

Wyre

# Entrance door designs

**1** Select door style:



• Bakewell •



• Dunham •

# Decorative glazing options

**2** Select corresponding glass:



Kensington



Victorian Boarder

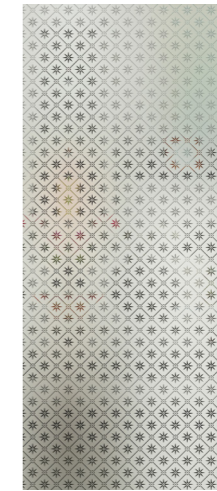

Mayfair

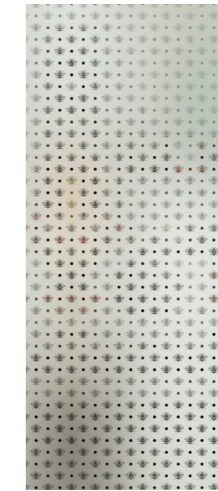

Worker Bee

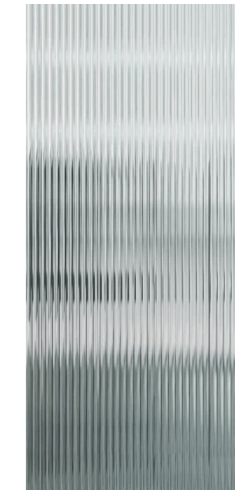

Fluted



Kensington



Victorian Boarder



Mayfair

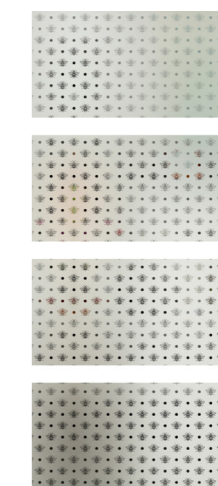

Worker Bee

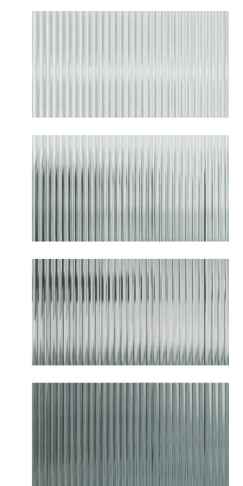

Fluted

# Entrance door designs

1 Select door style:



• Chester •



• Whitby •

# Decorative glazing options

2 Select corresponding glass:



Victorian Boarder



Mayfair



Worker Bee



Fluted



Kensington



Victorian Boarder

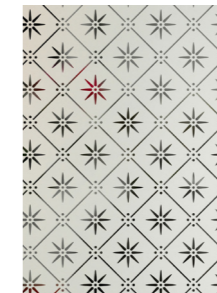

Mayfair



Worker Bee



Fluted



# Hardware

8 ranges from 2 suppliers



The Hardwick range is designed to complement quality timber doors and windows. With matching finishes across door levers, entrance doors, casement windows, and sash windows, Hardwick provides the perfect opportunity to simplify the choice of hardware while maintaining a consistent look across different products.



From Llandrindod Wells, Wales 'From The Anvil' boast over twenty three years of experience.

Combining beauty with durability, expert Blacksmiths hand craft exquisite products by forging mild steel and hot forging brass to make one-of-a-kind ironmongery that will last a lifetime. This is our super premium grade hardware.





HARDWICK

# Hardware



## Contents

- 79 Finishes
- 80 Hardware for joiners
- 82 Entrance door hardware
- 86 Door hardware
- 88 Sentry+ Euro Cylinders
- 90 Sash window hardware
- 92 Casement window hardware

# Available finishes

Distinctive finishes are the hallmark of Hardwick ironmongery.

Offering matching finishes across door levers, entrance doors, casement windows, and sash windows, Hardwick provides the perfect

opportunity to simplify your choice of hardware while maintaining a consistent look across different joinery products.



Six distinctive finishes define the Hardwick Classic range, each designed to suit both traditional and modern settings. With matching options across doors and windows, it's easy to create a consistent look throughout your project.



Antique Brass (AB)

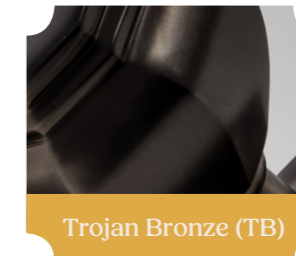

Trojan Bronze (TB)



Satin Chrome (SCP)



Satin Brass (SB)



Polished Brass (PB)



Chrome Plated (CP)



The Hardwick Heritage range features a forged black finish, combining traditional character with the strength of solid brass for authentic period styling and modern performance.



Forged Black (FB)

## Create your own statement look

Choose your style, then your finish. With matching options across doors and windows, it's easy to create a consistent look throughout your project.

# Hardware designed with joiners in mind

The Hardwick range is crafted from solid brass, designed to complement quality timber doors and windows. With matching finishes across door levers, entrance doors, casement windows, and sash windows, Hardwick provides the perfect opportunity to simplify your choice of hardware while maintaining a consistent look across different joinery products.

## Handing

There are left and right hand versions of some ironmongery products;

**Door handles** - viewed from outside



Right Hand

Left Hand

**Window Handles** - viewed from inside



Left Hand

Right Hand



## Finishes

Seven matching finishes across our Classic and Heritage ranges, with matching hardware for doors and windows for a consistent look throughout your project.



## Testing

Tested to over 10,000 cycles, all Hardwick ironmongery is built to last, combining the strength of solid brass with smooth performance for both doors and windows.



## Suitable for Accoya

Made from solid brass and supplied with stainless steel fixings, every Hardwick product is suitable for use with Accoya, offering durability and long-lasting performance.



# Entrance door hardware

## Classic Range



Available finishes:  
(See page 83 for more info)

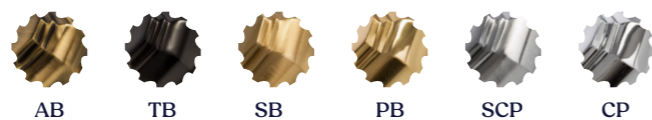

**Ryhall centre door knob**  
HK4100

- Bolt-through centre door knob
- Manufactured from solid brass and supplied with matching stainless steel fixings



**Ayston centre door knob**  
HK4110

- Bolt-through centre door knob
- Manufactured from solid brass and supplied with matching stainless steel fixings



**Hambleton centre door knob**  
HK4120

- Bolt-through centre door knob
- Manufactured from solid brass and supplied with matching stainless steel fixings



**Ryhall doctor's knocker**  
HK4200

- Classic doctor's door knocker
- Manufactured from solid brass and supplied with matching stainless steel fixings



**Ayston ring knocker**  
HK4210

- Stylish ring door knocker
- Manufactured from solid brass and supplied with matching stainless steel fixings



**Bumblebee door knocker**  
HK4220

- Characterful door knocker
- Manufactured from solid brass and supplied with matching stainless steel fixings

# Entrance door hardware

## Classic Range



Available finishes:  
(See page 83 for more info)

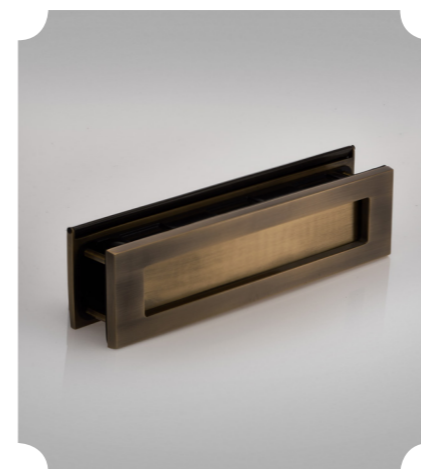
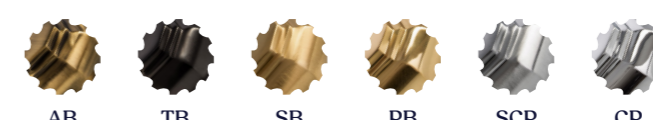

**Sleeved letterbox**  
HK4350

- Classic design of letterplate and tidy combined
- Fully weathersealed with double brush to prevent draughts



**Euro cylinder door pull set**  
HK4005

- Back-to-back euro pull set
- Manufactured from solid brass and supplied with matching stainless steel fixings



**Embossed LETTERS letterbox + knocker**

- Classic design of letterplate and tidy combined
- Fully weathersealed with double brush to prevent draughts
- Embossed 'LETTERS' design



**Embossed LETTERS letterbox**

- Classic design of letterplate and tidy combined
- Fully weathersealed with double brush to prevent draughts
- Embossed 'LETTERS' design



**Euro profile door escutcheon**  
HK4010

- Euro profile escutcheon with concealed fixing points
- Manufactured from solid brass and supplied with matching stainless steel fixings

# Entrance door hardware

## Heritage Range



**Available finishes:**  
(See page 83 for more info)



FB



**Ayston centre door knob**  
HKH710

- Bolt-through centre door knob
- Manufactured from solid brass with electrostatic black coating and supplied with matching stainless steel fixings



**Ayston ring knocker**  
HKH720

- Stylish ring door knocker
- Manufactured from solid brass with electrostatic black coating and supplied with matching stainless steel fixings



**Bumblebee door knocker**  
HKH715

- Characterful door knocker
- Manufactured from solid brass with electrostatic black coating and supplied with matching stainless steel fixings



**Euro cylinder door pull set**  
HKH700

- Back-to-back euro pull set
- Manufactured from solid brass with electrostatic black coating and supplied with matching stainless steel fixings



**Euro profile door escutcheon**  
HKH705

- Euro profile escutcheon with concealed fixing points
- Manufactured from solid brass with electrostatic black coating and supplied with matching stainless steel fixings

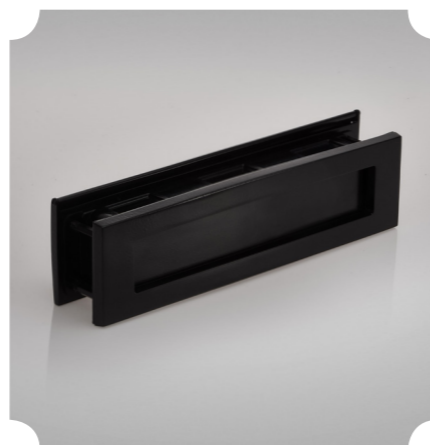

**Sleeved letterbox**  
HKH725

- Combined letterplate and tidy with double brush weatherseal and external gasket to prevent draughts
- Manufactured from solid brass with electrostatic black coating and supplied with matching St.St. fixings



# Door hardware

## Classic Range



Available finishes:  
(See page 83 for more info)

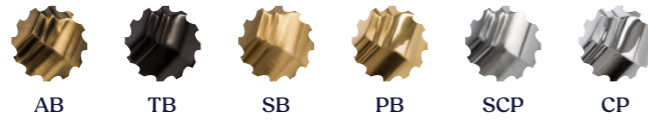

**Classic Lyndon Espag Lever Door Handle**  
HK3050

- 92mm centres to suit multipoint locks
- Smooth operating dual-action spring cassette in backplate
- Manufactured from solid brass and supplied with matching stainless steel fixings



**Classic Burley Espag Lever Door Handle**  
HK3200

- 92mm centres to suit multipoint locks
- Smooth operating dual-action spring cassette in backplate
- Manufactured from solid brass and supplied with matching stainless steel fixings



**Classic Preston Espag Lever Door Handle**  
HK3300

- 92mm centres to suit multipoint locks
- Smooth operating dual-action spring cassette in backplate
- Manufactured from solid brass and supplied with matching stainless steel fixings



**Classic Cottesmore Espag Lever Door Handle**  
HK3100 - Left Hand / HK3101 - Right Hand

- 92mm centres to suit multipoint locks
- Smooth operating dual-action spring cassette in backplate
- Manufactured from solid brass and supplied with matching stainless steel fixings

# Door hardware

## Heritage Range



Available finishes:  
(See page 83 for more info)



**Heritage Lyndon Espag Lever Door Handle**  
HKH630

- 92mm centres to suit multipoint locks
- Smooth operating dual-action spring cassette in backplate
- Manufactured from solid brass with electrostatic black coating and supplied with matching stainless steel fixings



**Heritage Burley Espag Lever Door Handle**  
HKH600

- 92mm centres to suit multipoint locks
- Smooth operating dual-action spring cassette in backplate
- Manufactured from solid brass with electrostatic black coating and supplied with matching stainless steel fixings



**Heritage Brooke Espag Lever Door Handle**  
HKH610

- 92mm centres to suit multipoint locks
- Smooth operating dual-action spring cassette in backplate
- Manufactured from solid brass with electrostatic black coating and supplied with matching stainless steel fixings



**Heritage Preston Espag Lever Door Handle**  
HKH620

- 92mm centres to suit multipoint locks
- Smooth operating dual-action spring cassette in backplate
- Manufactured from solid brass with electrostatic black coating and supplied with matching stainless steel fixings

# Sentry+ Euro Cylinders

## Classic Range



## Beautifully secured.

Details make the difference when creating “stand-out” doors.

Sentry+ by Hardwick 3\* Euro Cylinders offer high-security performance with precision engineered durability.

Tested to BSI 3-star standards they are resistant to tampering and provide smooth operation with horizontal keyway.

Available in four finishes (satin chrome plated, satin brass, antique brass and black) to match with your door hardware for a secure solution.



Available finishes:  
(See page 83 for more info)

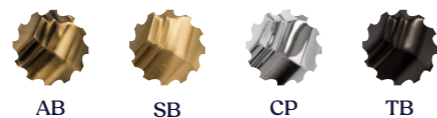

Key/Key 3\* Euro cylinder



Key/Turn 3\* Euro cylinder

# Sash window hardware

## Classic Range



Available finishes:  
(See page 83 for more info)

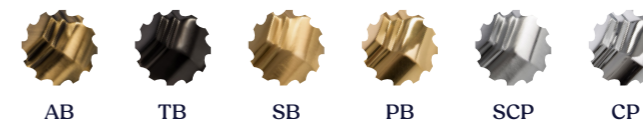

Classic ball knob narrow claw fastener  
HK1075

- Lockable with hex key (supplied)
- Manufactured from solid brass and supplied with matching stainless steel fixings



Classic reeded narrow claw fastener  
HK1077

- Lockable with hex key (supplied)
- Manufactured from solid brass and supplied with matching stainless steel fixings



Classic narrow fitch fastener  
HK1080

- Lockable with hex key (supplied)
- Manufactured from solid brass and supplied with matching stainless steel fixings

# Sash window hardware

## Classic Range



Available finishes:  
(See page 83 for more info)

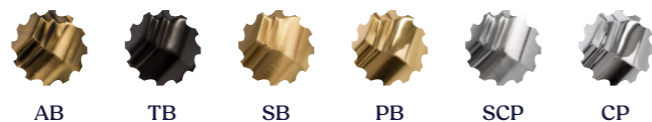

**Classic curved neck sash lift**

HK1090

- Traditional cast sash lift
- Manufactured from solid brass and supplied with matching stainless steel fixings



**Classic sash handle**  
HK1095-32

- 120mm sash handle
- Manufactured from solid brass and supplied with matching stainless steel fixings



**Classic sash eye**  
HK1096

- Traditional cast sash eye
- Manufactured from solid brass and supplied with matching stainless steel fixings



**Classic ball bearing pulley**  
HK1051 - Radius End

- 45mm wheel, 80kg ball bearing sash pulley
- Manufactured from solid brass and supplied with matching stainless steel fixings

# Sash window hardware

## Classic Range



Available finishes:  
(See page 83 for more info)

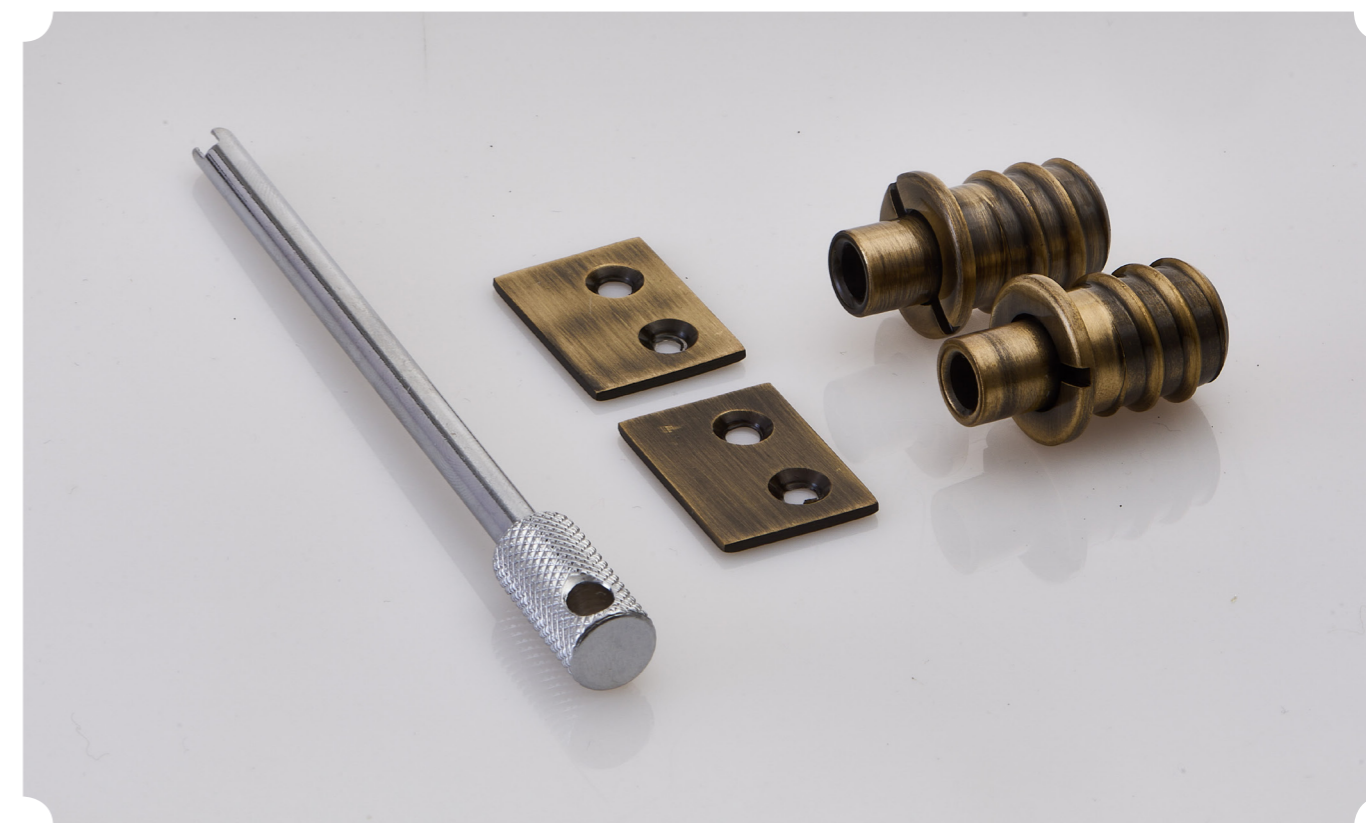
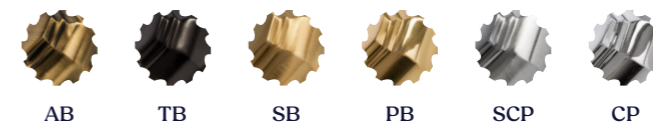

**Classic flush stop set**

HK1087-19 - 19mm / HK1087-30 - 30mm

- 2 x stops, 2 x strikes and key
- Manufactured from solid brass and supplied with matching stainless steel fixings

# Casement window hardware

## Classic Range



Available finishes:  
(See page 83 for more info)

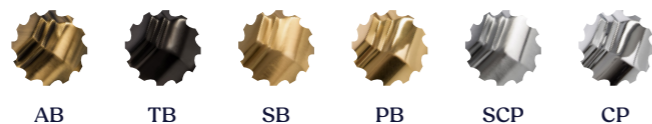

**Lyndon espagnolette handle**  
HK2050 - LH / HK2051 - RH

- Lockable handle with 40mm spindle
- Manufactured from solid brass and supplied with matching stainless steel fixings



**Lyndon casement stay**  
HK2070 - 8" / HK2074 - 10" / HK2075 - 12"

- Window stay available in 8"/202mm, 10"/254mm and 12"/305mm
- Supplied with 2 stay-pins
- Manufactured from solid brass and supplied with matching stainless steel fixings



**Lyndon locking night vent casement fastener**  
HK2060 - LH / HK2061 - RH

- Lockable handle with night vent
- Manufactured from solid brass and supplied with matching stainless steel fixings



**Lyndon hp/mp casement fastener**  
HK2065

- Hook plate and mortice plate keeps
- Manufactured from solid brass and supplied with matching stainless steel fixings



**Casement stay locking pin**  
HK2999

- Lockable stay-pin to suit all Classic Range window stays
- Manufactured from solid brass and supplied with matching stainless steel fixings

# Casement window hardware

## Classic Range



Available finishes:  
(See page 83 for more info)

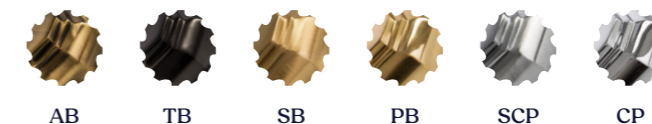

**Burley espagnolette handle**  
HK2200 - LH / HK2201 - RH

- Lockable handle with 40mm spindle
- Manufactured from solid brass and supplied with matching stainless steel fixings



**Preston espagnolette handle**  
HK2300 - LH / HK2301 RH

- Lockable handle with 40mm spindle
- Manufactured from solid brass and supplied with matching stainless steel fixings



# Casement window hardware

## Heritage Range



Available finishes:  
(See page 83 for more info)



**Lyndon casement stay**  
HKH560 - 8" / HKH561 - 10" / HKH562 - 12"

- Window stay available in 8"/202mm, 10"/254mm and 12"/305mm
- Supplied with 2 stay-pins
- Manufactured from solid brass with electrostatic black coating and supplied with matching stainless steel fixings



**Curlytail casement stay**  
HKH510 - 8" / HKH511 - 10" / HKH512 - 12"

- Window stay available in 8"/202mm, 10"/254mm and 12"/305mm
- Supplied with 2 stay-pins
- Manufactured from solid brass with electrostatic black coating and supplied with matching stainless steel fixings

# Casement window hardware

## Heritage Range



Available finishes:  
(See page 83 for more info)



**Burley espagnolette handle**  
HKH520 - LH / HKH521 - RH

- Lockable handle with 40mm spindle
- Manufactured from solid brass with electrostatic black coating and supplied with matching stainless steel fixings



**Lyndon espagnolette handle**  
HKH550 / HKH551

- Lockable handle with 40mm spindle
- Manufactured from solid brass with electrostatic black coating and supplied with matching stainless steel fixings



**Curlytail espagnolette handle**  
HKH500 / HKH501

- Lockable handle with 40mm spindle
- Manufactured from solid brass with electrostatic black coating and supplied with matching stainless steel fixings

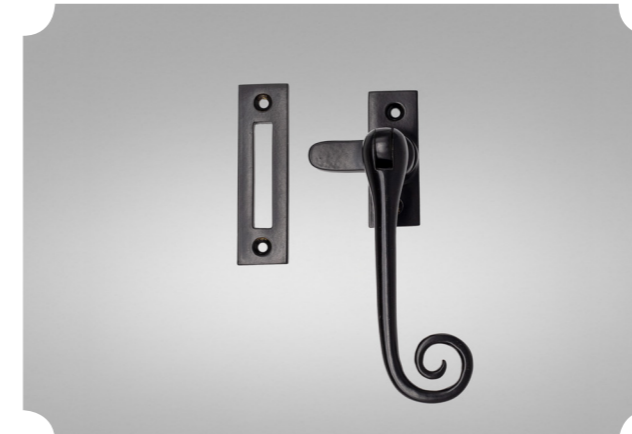

**Curlytail locking night vent casement fastener**

- Lockable handle with night vent
- Manufactured from solid brass with electrostatic black coating and supplied with matching stainless steel fixings

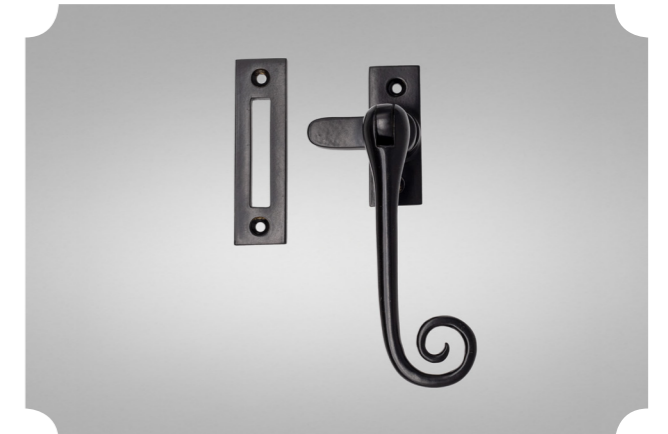

**Curlytail MP casement fastener**

- Hook plate keeps
- Manufactured from solid brass with electrostatic black coating and supplied with matching stainless steel fixings

# Hardware



## Contents

- 97 Finishes
- 98 Brompton Range
- 99 Newbury Range
- 100 Monkeytail Range

# Finishes



Aged  
brass

Matt  
black

Satin  
brass

Polished  
chrome

Polished  
brass



Polished  
nickel

Aged  
bronze

Black

Pewter

# Brompton

From the  
**Anvil**<sup>®</sup>

- Flush and stormproof shootbolt windows
- Flush and stormproof peg and stay windows
- Entrance, French and Bi-folding doors

Available in: Aged Brass, Matt Black, Satin Brass, Polished Chrome, Polished Brass, Polished Nickel and Aged Bronze

Illustrated in Aged brass



Shootbolt handle



Peg stay, fastener and butt hinge



Door handle



Letterbox



Door hinge



Door pull



Doorknob



Brompton knocker



Art decor knocker



Doctor knocker

# Newbury

From the  
**Anvil**<sup>®</sup>

- Flush and stormproof shootbolt windows
- Flush and stormproof peg and stay windows
- Entrance, French and Bi-folding doors

Available in: Aged Brass, Matt Black, Satin Brass, Polished Chrome, Polished Brass, Polished Nickel and Aged Bronze

Illustrated in polished chrome



Shootbolt handle



Peg stay, fastener and butt hinge



Door handle



Letterbox



Door hinge



Door pull



Doorknob



Art decor knocker



Doctor knocker

# Monkeytail

From the  
**Anvil**<sup>®</sup>

- ✦ Flush and stormproof shootbolt windows
- ✦ Flush and stormproof peg and stay windows
- ✦ Entrance, French and Bi-folding doors

Available in: Black and Pewter

Illustrated in black



Shootbolt handle



Peg stay, fastener and butt hinge



Door handle



Letterbox



Door hinge



Door pull



Doorknob



Art decor knocker



Doctor knocker



# Modern

## Entrance doors



Satin stainless steel



Matt black



1800mm



1500mm



1200mm

# Sliding door handle

## Sliding doors



White



Premium satin



Graphite



Chrome



Gold



Antique black



Black

# Peace of mind guarantee

For four decades we've perfected the raw materials we buy and the joinery techniques we use to allow us to confidently offer 'peace of mind' guarantees to be proud of.

All guarantees shown below are for timber windows and doors made using Accoya, in accordance with our maintenance guidelines.

## Fungal and Insect



## Workmanship



## Glass Unit



## Hardware



## Paint



## Stain



\* Our 25 year fungal & insect guarantee applies to Accoya products only

\* Our standard 24mm and 44mm glazing comes with a 10 year guarantee, however 14mm slimline double glazing come with a 5 year guarantee

\* Our 10 year paint guarantee is against paint failure. We generally recommend repainting every 5 years to keep product looking fresh and clean

All guarantees are given in accordance with our guarantee T&C's available on the downloads section of our website.



# Quality controlled to perfection

All our frames go through a stringent QC check before delivery, ensuring that our hand crafted quality is guaranteed.

A simple mark of approval that takes seconds to stamp, but represents 40 years of craftsmanship.



**Honouring Craft.  
Delivering Excellence.**

# Flush window

Multipoint lock and friction hinge



Double Glazed U-Value



Triple Glazed U-Value



Available



## About:

Our flush windows are hand crafted to perfection, offering a traditional look outside the property with the window sash finishing flush with the frame.

This version comes with multipoint secure locking and friction hinges, meaning PAS24 can be achieved. Available with both double and triple glazing.

## Feature:

- Seamless corner joints, using twin mortice and tenon joints on all sash corners
- Flush-fit colour matching trickle vents, made from aluminium
- Three coat factory paint finish, dual colour available
- Externally beaded for tradition, taped glass for high security
- Range of cill sizes available
- Available with a large outerframe (20mm bigger) or a 20mm add on supplied separately
- Head drips sent with all frames
- Crafted by experts
- 70+ year life expectancy

## Specification:

- Multipoint secure lock with night vent position
- Available with a range of hardware options
- High security friction hinges, egress as standard on all side openers
- 1.2 whole window U value with double glazing
- 0.73 whole window U value with triple glazing
- PAS24 available

## Section details:

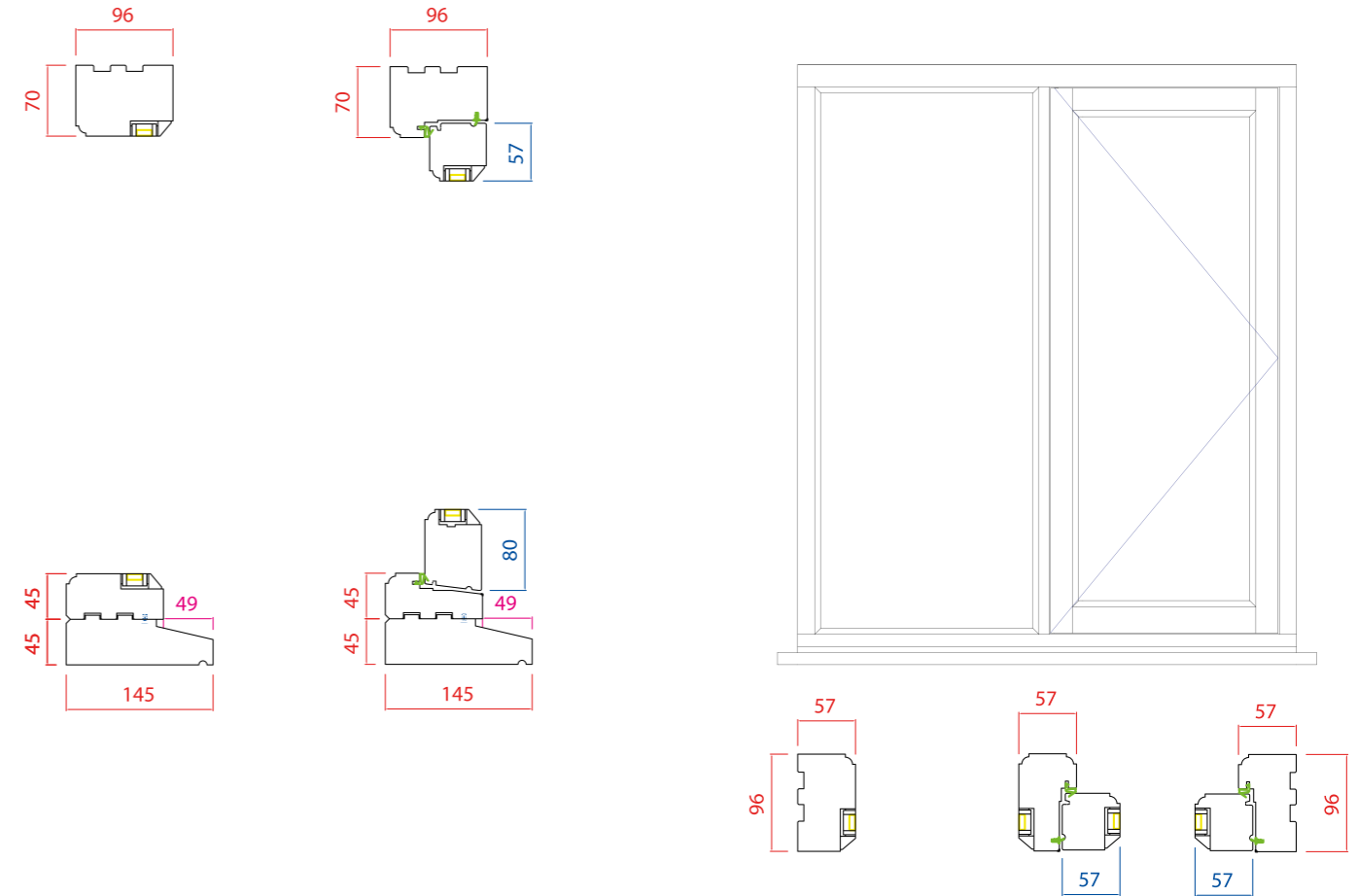

## Cill options:

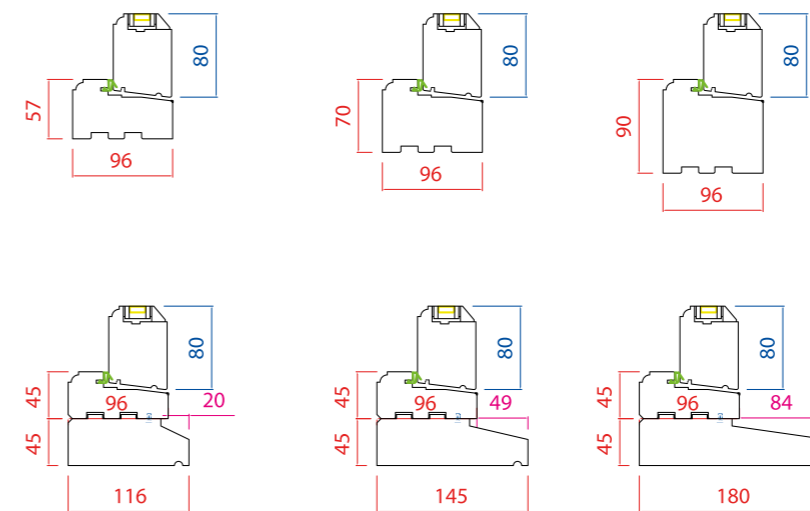

## Air vent in frame:

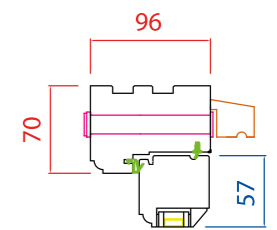

# Flush window

Peg stay and butt hinge

**1.2**  
W/km<sup>2</sup>K

Double Glazed  
U-Value

**0.68**  
W/km<sup>2</sup>K

Triple Glazed  
U-Value

## About:

Our flush windows are hand crafted to perfection, offering a traditional look outside the property with the window sash finishing flush with the frame.

This version comes with a peg stay and butt hinge hardware option, for a traditional look. Available with both double and triple glazing.



## Section details:

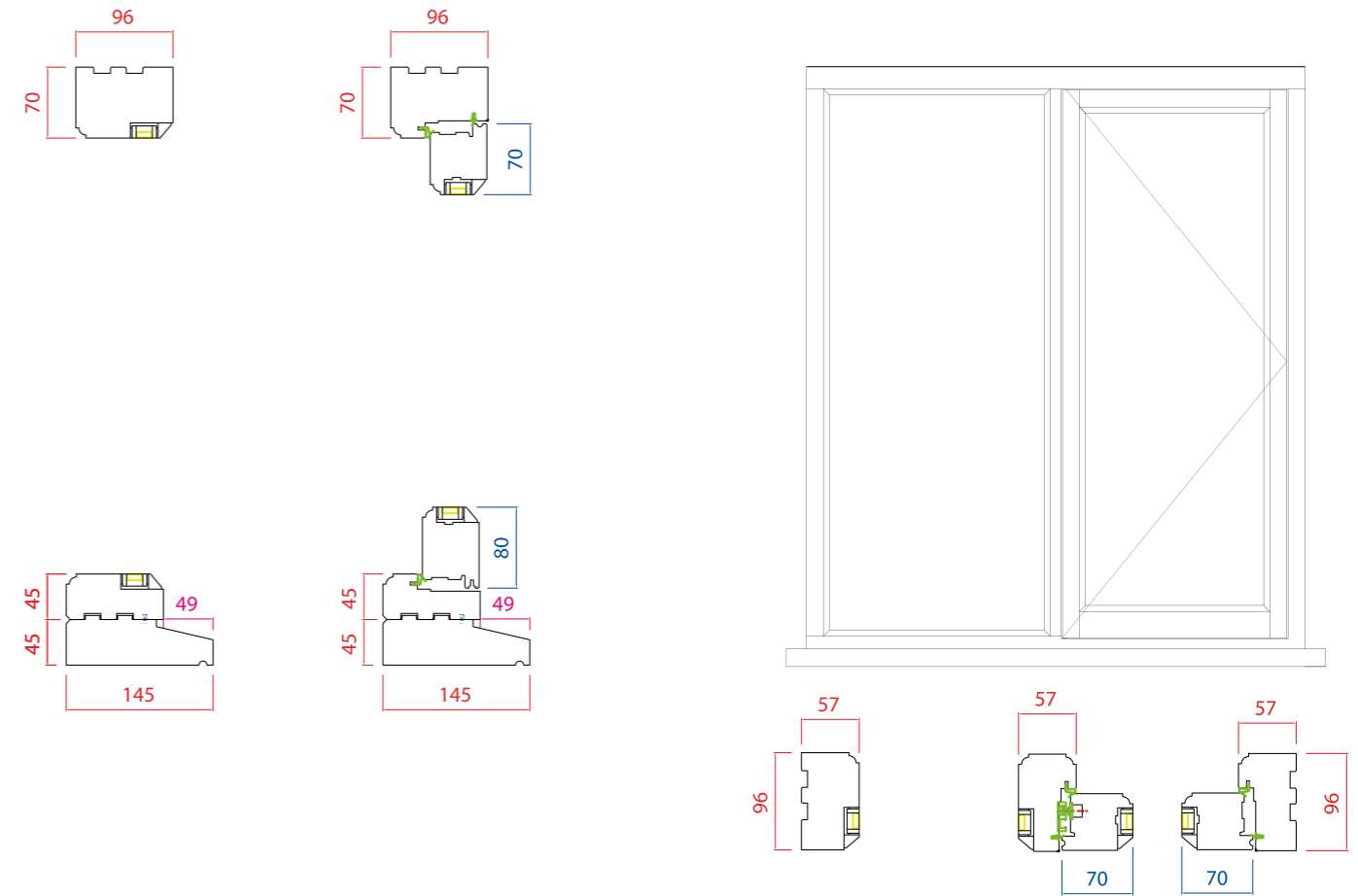

## Feature:

- Seamless corner joints, using twin mortice and tenon joints on all sash corners
- Flush-fit colour matching trickle vents, made from aluminium
- Three coat factory paint finish, dual colour available
- Externally beaded for tradition, taped glass for high security
- Range of cill sizes available
- Available with a large outerframe (20mm bigger) or a 20mm add on supplied separately
- Head drips sent with all frames
- Crafted by experts
- 70+ year life expectancy

## Specification:

- Traditional looking peg-stay, fastener and hinge
- Available with a range of hardware options
- 1.2 whole window U value with double glazing
- 0.68 whole window U value with triple glazing

## Cill options:

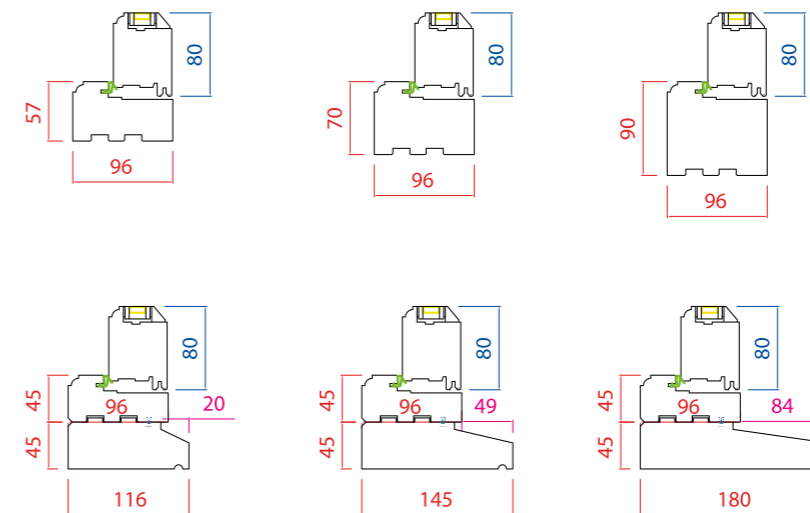

## Air vent in frame:

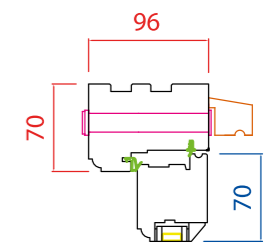

# Stormproof window

Multipoint lock and friction hinge

**1.2**

W/km<sup>2</sup>K  
Double Glazed  
U-Value

**0.72**

W/km<sup>2</sup>K  
Triple Glazed  
U-Value



## About:

Our stormproof windows are hand crafted to perfection, offering double rebated protection against the outside elements.

This version comes with multipoint secure locking and friction hinges. Available with both double and triple glazing.

## Feature:

- Seamless corner joints, using twin mortice and tenon joints on all sash corners
- Flush-fit colour matching trickle vents, made from aluminium
- Three coat factory paint finish, dual colour available
- Externally beaded for tradition, taped glass for high security
- Range of cill sizes available
- Available with a large outerframe (20mm bigger) or a 20mm add on supplied separately
- Head drips sent with all frames
- Crafted by experts
- 70+ year life expectancy

## Specification:

- Multipoint secure lock with night vent position
- Available with a range of hardware options
- High security friction hinges, egress as standard on all side openers
- 1.2 whole window U value with double glazing
- 0.72 whole window U value with triple glazing

## Section details:

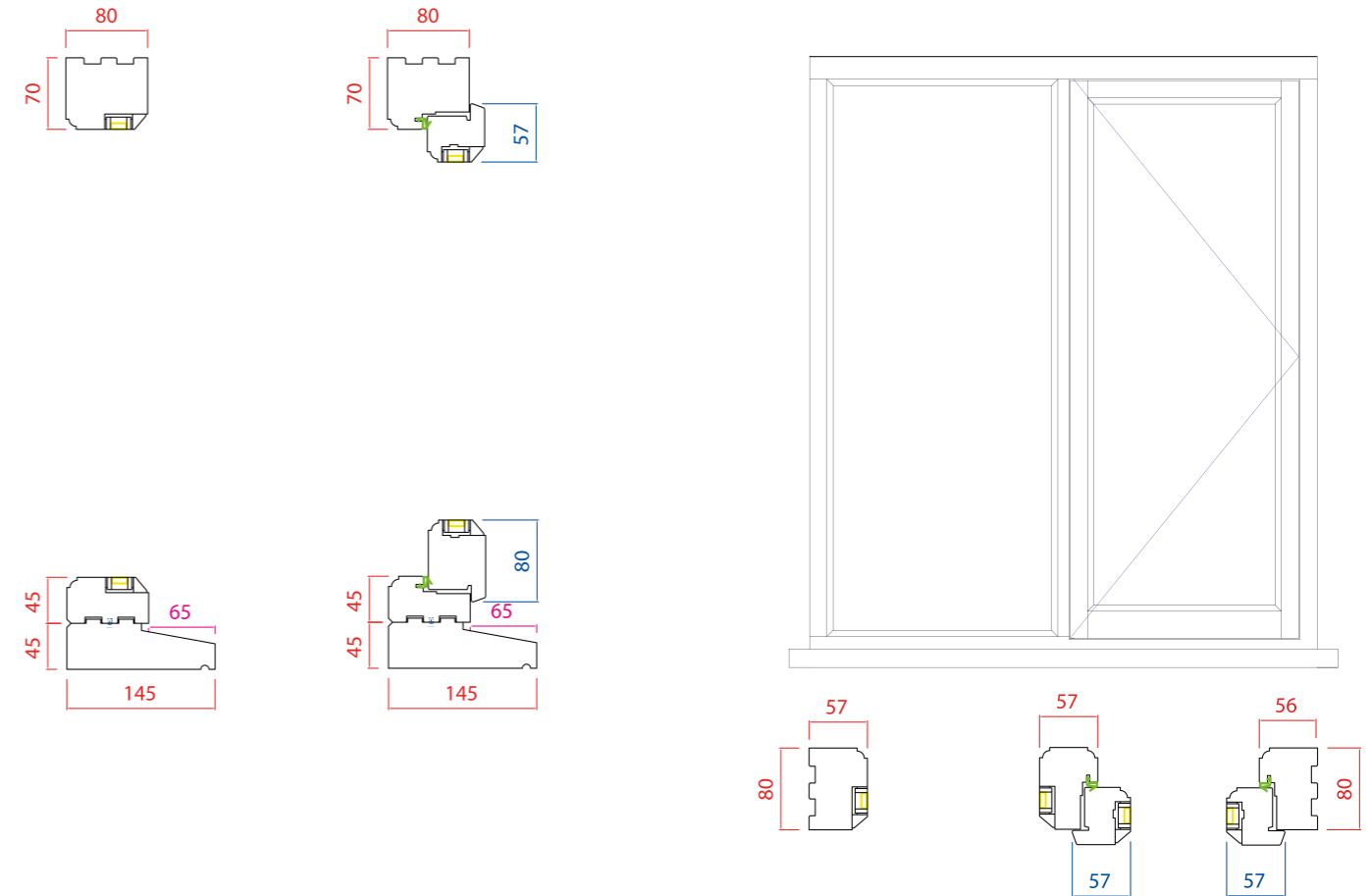

## Cill options:

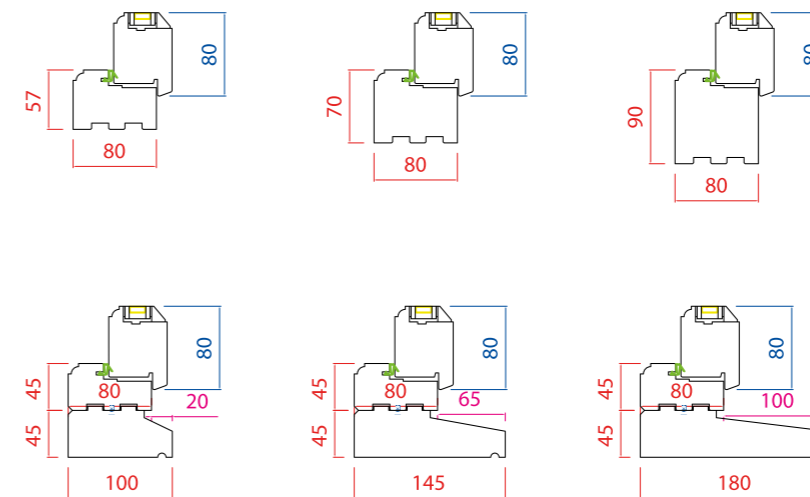

## Air vent in frame:

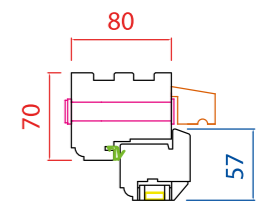

# Stormproof window

Peg stay and butt hinge

**1.2**

W/km<sup>2</sup>K

Double Glazed  
U-Value

**0.70**

W/km<sup>2</sup>K

Triple Glazed  
U-Value



## About:

Our stormproof windows are hand crafted to perfection, offering double rebated protection against the outside elements.

This version comes with peg-stays, fasteners and stormproof butt hinges to maintain a more traditional look and feel. Available with both double and triple glazing.

## Feature:

- Seamless corner joints, using twin mortice and tenon joints on all sash corners
- Flush-fit colour matching trickle vents, made from aluminium
- Three coat factory paint finish, dual colour available
- Externally beaded for tradition, taped glass for high security
- Range of cill sizes available
- Available with a large outerframe (20mm bigger) or a 20mm add on supplied separately
- Head drips sent with all frames
- Crafted by experts
- 70+ year life expectancy

## Specification:

- Traditional looking peg-stay, fastener and hinge
- Available with a range of hardware options
- 1.2 whole window U value with double glazing
- 0.70 whole window U value with triple glazing

## Section details:

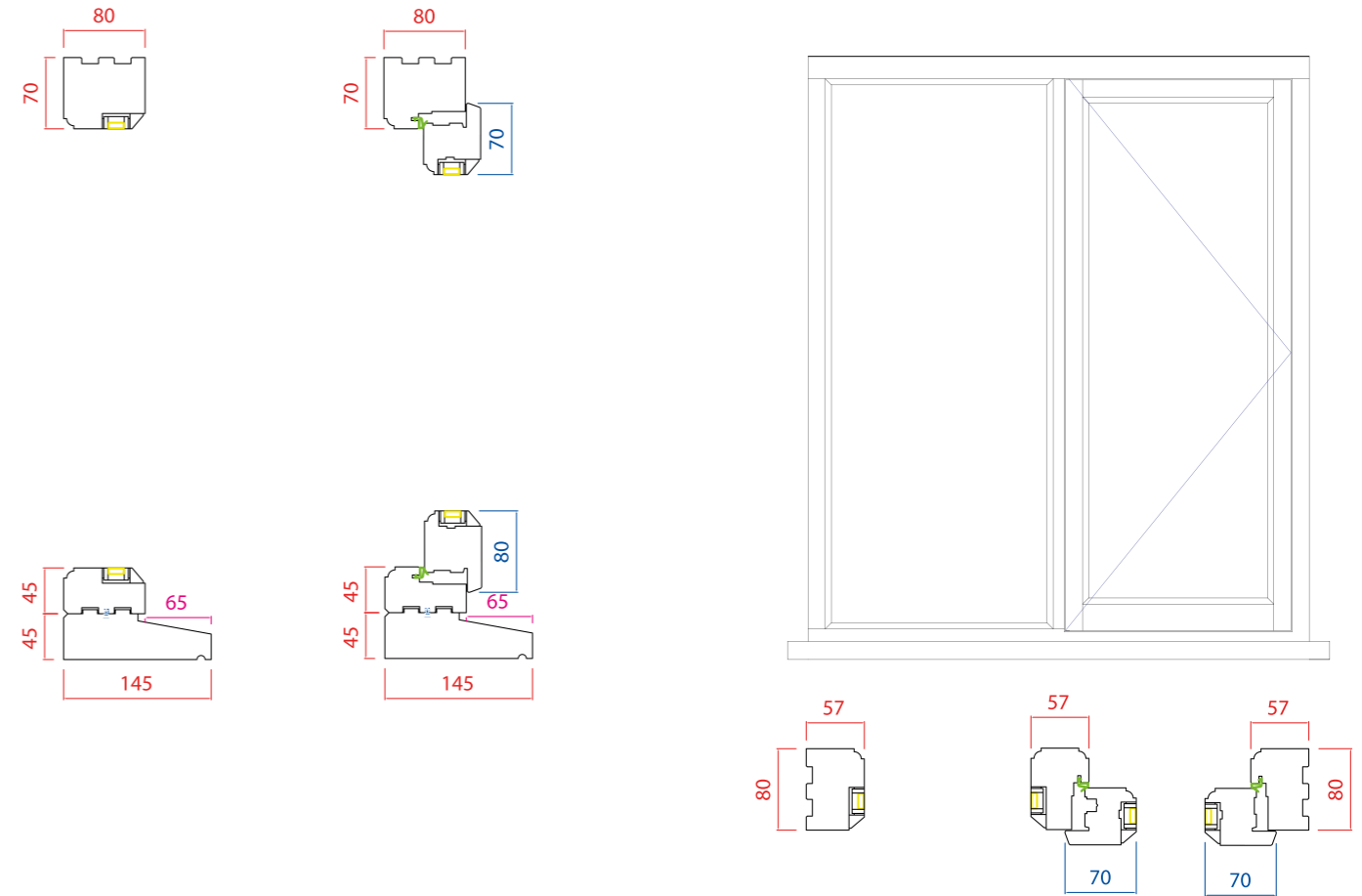

## Cill options:

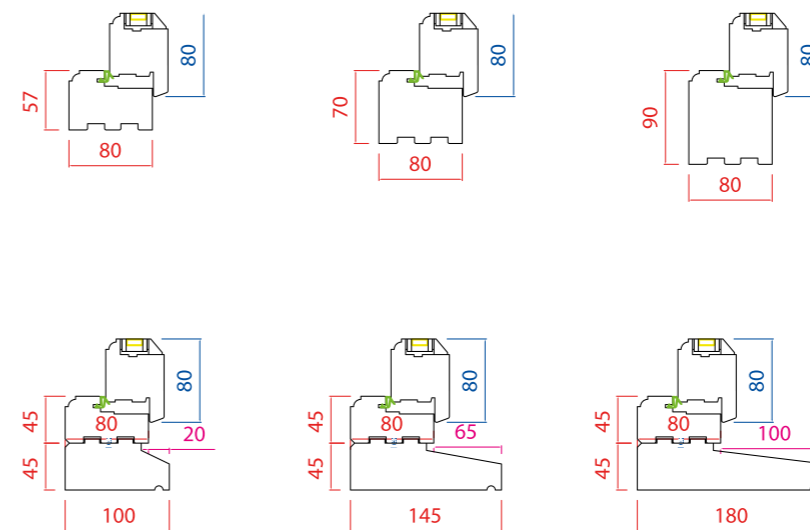

## Air vent in frame:

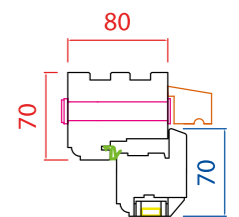

# Sash window

Spiral balance

**1.2**  
W/km<sup>2</sup>K

Double Glazed  
U-Value

**0.77**  
W/km<sup>2</sup>K

Triple Glazed  
U-Value

**PAS24**

Available



## About:

Our sash windows are hand crafted to perfection, boasting classic sash aesthetics with smooth long lasting operation. This option with spiral balance sliding which can be PAS24 compliant.

## Feature:

- Seamless corner joints, using twin mortice and tenon joints on all sash corners
- Flush-fit colour matching trickle vents, made from aluminium
- Three coat factory paint finish, dual colour available
- Externally beaded for tradition, taped glass for high security
- Available with a large outerframe (20mm bigger) or a 20mm add on supplied separately
- Crafted by experts
- 70+ year life expectancy

## Specification:

- Available with a range of hardware options
- 1.2 whole window U value with double glazing
- 0.77 whole window U value with triple glazing
- PAS24 available
- Choice of 4 internal staff bead and external lining options
- Choice of 5 sash horn styles

## Slimline version also available

We also offer a slimline sash window, available with either spiral balance or lead weight openings. The slimline sash accommodates 14mm double glazing and comes with a slimmer meeting rail & sashes. The perfect solution for conservation areas.

Contact us for CAD drawings of this product.

## Section details:

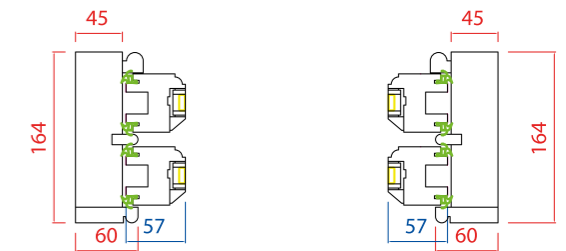
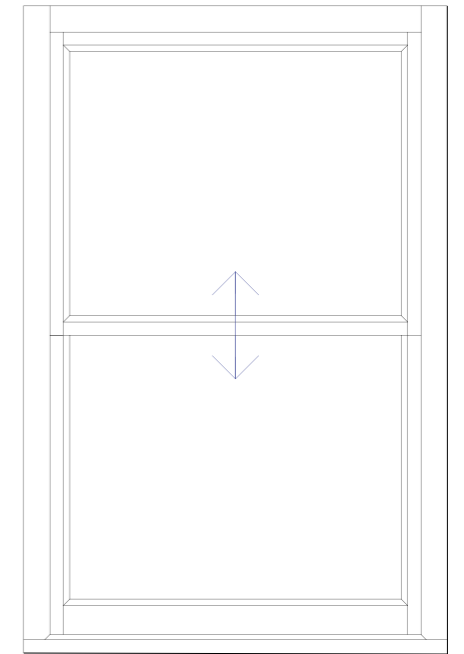
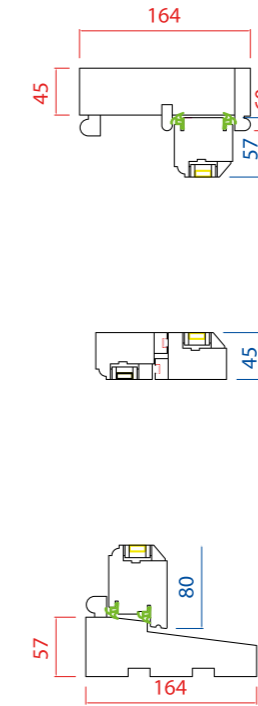

## Cill options:

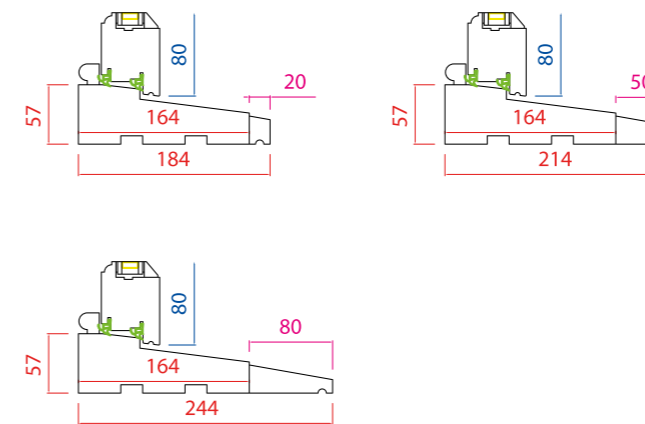

## Air vent in frame:

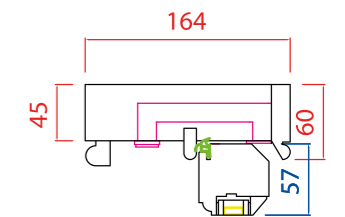

# Sash window

Lead weight

**1.3**

W/km<sup>2</sup>K

Double Glazed  
U-Value

**0.90**

W/km<sup>2</sup>K

Triple Glazed  
U-Value

## About:

Our sash windows are hand crafted to perfection, boasting classic sash aesthetics with smooth long-lasting operation.

Lead weight sash windows allow the sash to slide smoothly and freely up and down. The sash weight is matched to the lead weights, attached with a sash cord over an axel pulley wheel, resulting in a completely frictionless motion of travel.



## Section details:

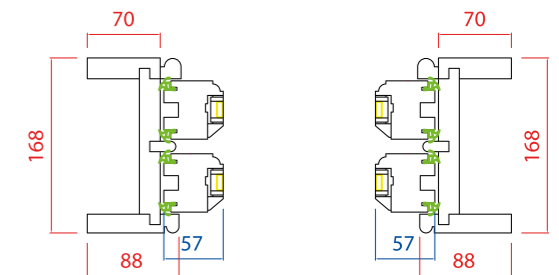
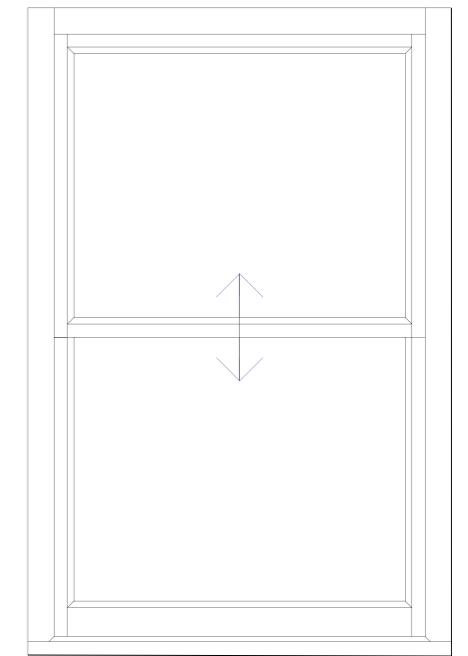
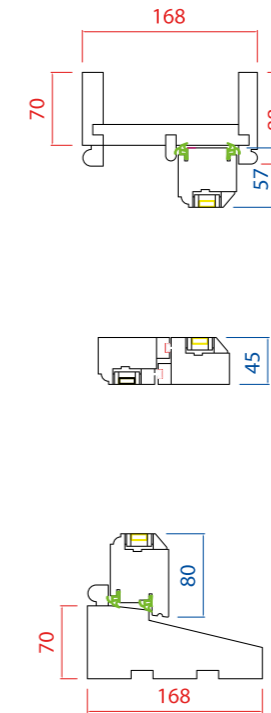

## Feature:

- Seamless corner joints, using twin mortice and tenon joints on all sash corners
- Flush-fit colour matching trickle vents, made from aluminium
- Three coat factory paint finish, dual colour available
- Externally beaded for tradition, taped glass for high security
- Available with a large outerframe (20mm bigger) or a 20mm add on supplied separately
- Crafted by experts
- 70+ year life expectancy

## Specification:

- Available with a range of hardware options
- The ultimate in honouring traditional methods
- Frictionless motion of travel, up and down
- 1.3 whole window U value with double glazing
- 0.9 whole window U value with triple glazing
- Choice of 4 internal staff bead and external lining options
- Choice of 5 sash horn styles

## Slimline version also available

We also offer a slimline sash window, available with either spiral balance or lead weight openings. The slimline sash accommodates 14mm double glazing and comes with a slimmer meeting rail & sashes. The perfect solution for conservation areas.

Contact us for CAD drawings of this product.

## Cill options:

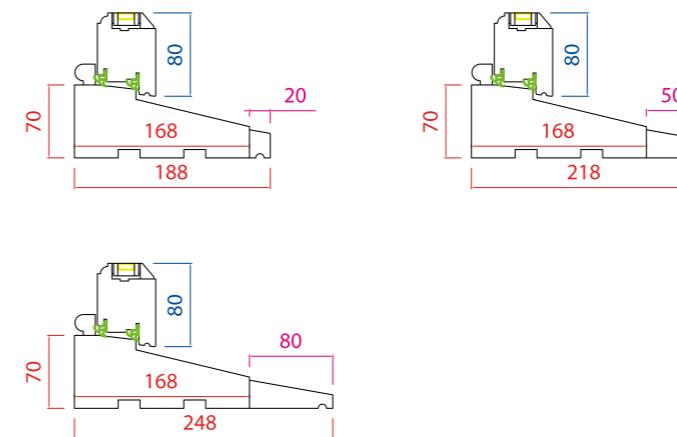

## Air vent in frame:

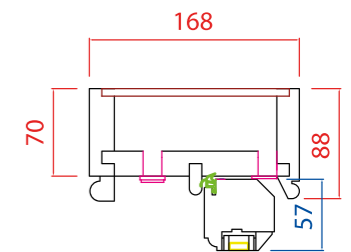

# Entrance door

**1.2**  
W/km<sup>2</sup>K

Double Glazed  
U-Value

**0.72**  
W/km<sup>2</sup>K

Triple Glazed  
U-Value

**PAS24**

Available

## About:

Our high security entrance doors are available in a range of styles, catering for traditional and modern needs. We offer a range of glass options to compliment each design. Using Maco multipoint door locks, Ultion 3\* door cylinders and solid Accoya, our entrance doors are not only beautiful, but also safe and secure from unwanted intruders.



## Feature:

- Seamless corner joints, using twin mortice and tenon joints on all sash corners
- Flush-fit colour matching trickle vents, made from aluminium
- Three coat factory paint finish, dual colour available
- Vertically factory hung, ensuring perfect positioning and squareness
- Externally beaded for tradition, taped glass for high security
- Available with a large outerframe (20mm bigger) or a 20mm add on supplied separately
- Available with a stable door opening mechanism
- Crafted by experts
- 70+ year life expectancy

## Specification:

- Exitex low threshold for easy access, available in 3 finishes
- High security multi-point door lock
- 3\* high security cylinders as standard
- Made from solid Accoya, reliably trusted to not visibly swell, shrink or distort
- Highly decorative details, such as bolection mouldings and R&F panels -style that cannot be matched by uPVC or GRP Composite doors
- Available with a range of hardware options
- 1.2 whole door U value with double glazing
- 0.71 whole door U value with triple glazing
- PAS24 available

## Section details:

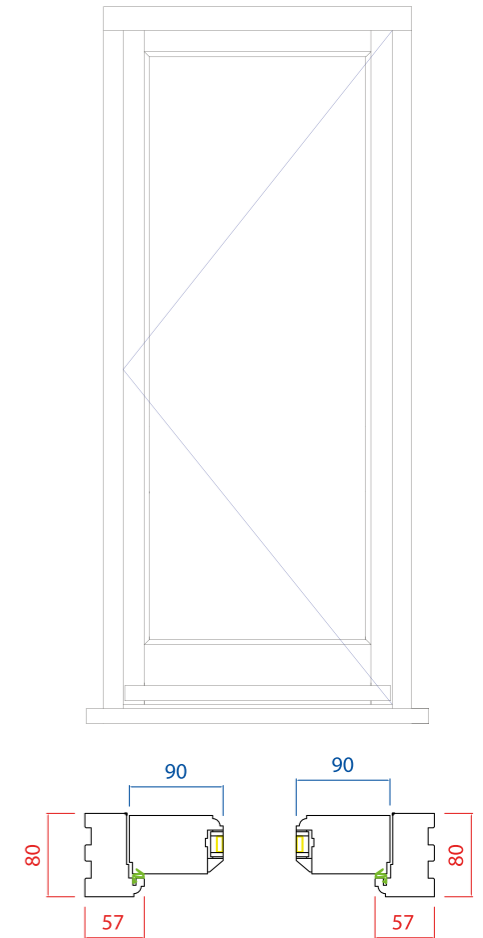
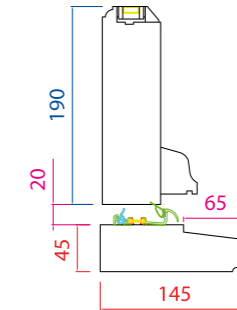
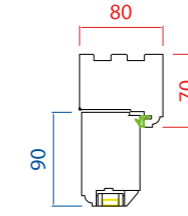

## Cill options:

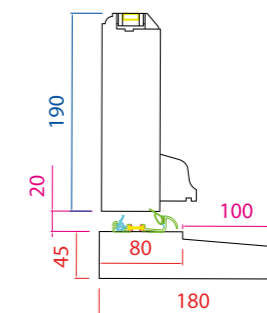
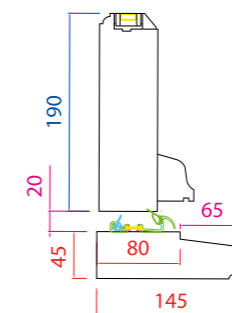
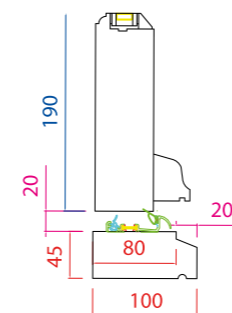
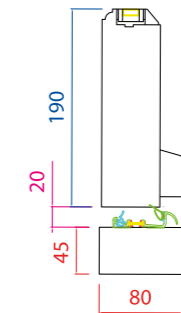
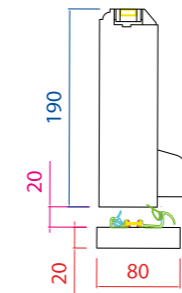
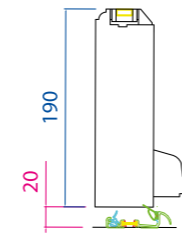

## Air vent in frame:

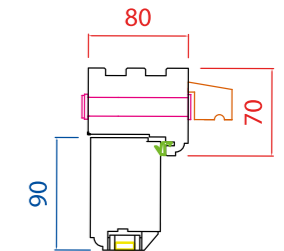

# French door

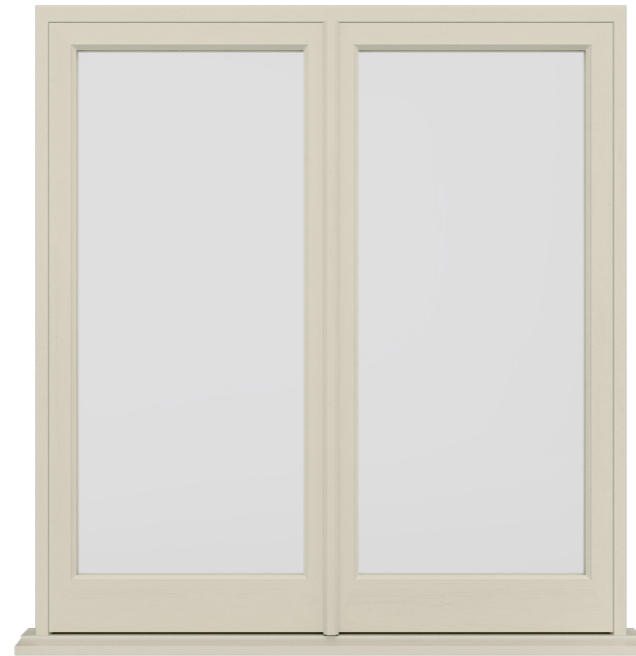

**1.2**  
W/km<sup>2</sup>K

Double Glazed  
U-Value

**0.73**  
W/km<sup>2</sup>K

Triple Glazed  
U-Value

**PAS24**

Available

## About:

Our high security French doors are available opening inwards or outwards, fitted with 2 fully functional multi point door locks and lever/lever handles.

Using Maco multipoint door locks, Ultion 3\* door cylinders and solid Accoya, our French doors are not only beautiful, but also safe and secure from unwanted intruders.

## Feature:

- Seamless corner joints, using twin mortice and tenon joints on all sash corners
- Flush-fit colour matching trickle vents, made from aluminium
- Three coat factory paint finish, dual colour available
- Vertically factory hung, ensuring perfect positioning and squareness
- Externally beaded for tradition, taped glass for high security
- Available with a large outerframe (20mm bigger) or a 20mm add on supplied separately
- Available in a range of styles
- Crafted by experts
- 70+ year life expectancy

## Specification:

- Exitex low threshold for easy access, available in 3 finishes
- High security multi-point door lock
- 3\* high security cylinders as standard
- Made from solid Accoya, reliably trusted to not visibly swell, shrink or distort
- Available with a range of hardware options
- 1.2 whole door U value with double glazing
- 0.73 whole door U value with triple glazing
- PAS24 available

## Section details:

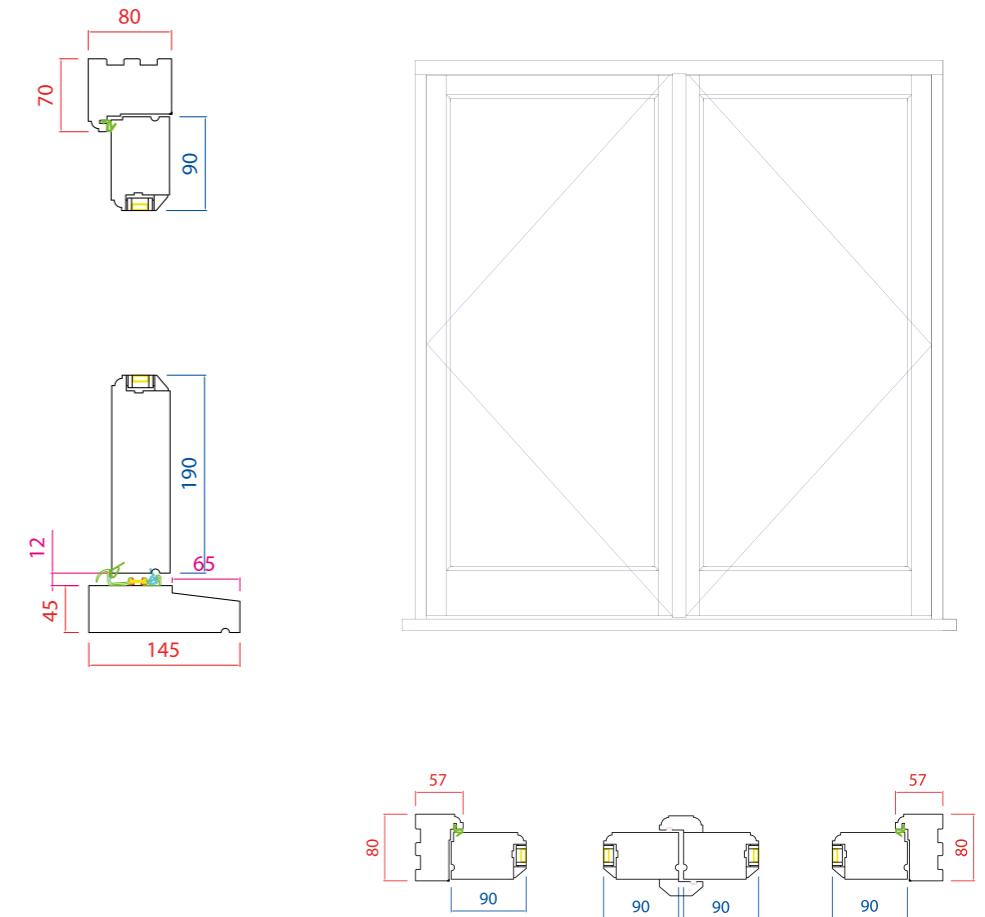

## Cill options:

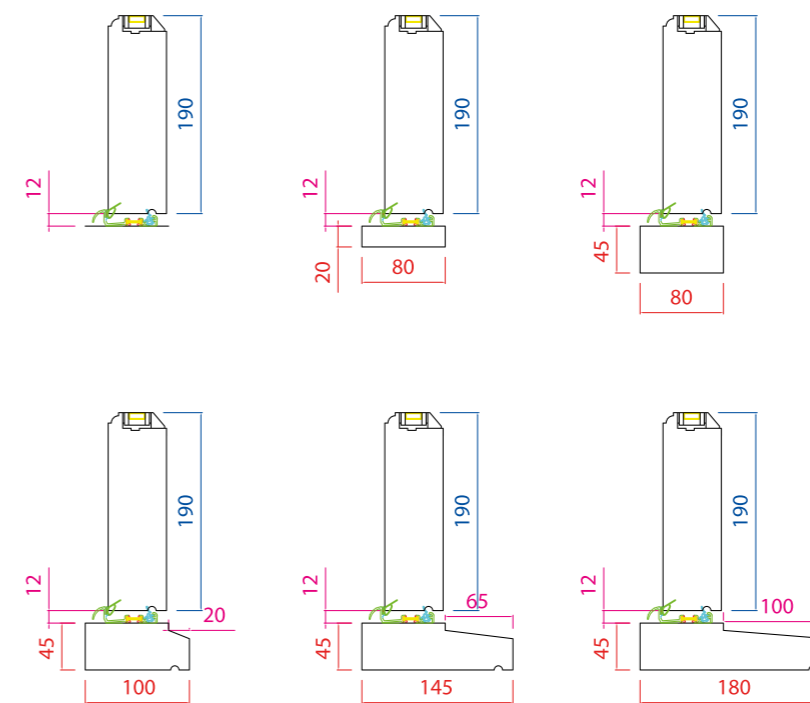

## Air vent in frame:

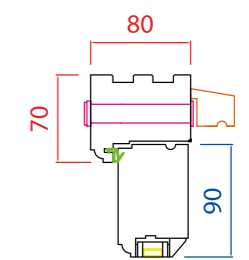

# Sliding door

**1.2**  
W/km<sup>2</sup>K

Double Glazed  
U-Value

**0.69**  
W/km<sup>2</sup>K

Triple Glazed  
U-Value



## About:

Our high security sliding doors are available in a range of configurations, all operating effortlessly.

Using multi-point locking, Ultion 3\* door cylinders and solid Accoya, our sliding doors are not only beautiful, but also safe and secure from unwanted intruders.

## Feature:

- Seamless corner joints, using twin mortice and tenon joints on all sash corners
- Flush-fit colour matching trickle vents, made from aluminium
- Three coat factory paint finish, dual colour available
- Vertically factory hung, ensuring perfect positioning and squareness
- Externally beaded for tradition, taped glass for high security
- Available with a large outerframe (20mm bigger) or a 20mm add on supplied separately
- Available in a range of configurations
- Crafted by experts
- 70+ year life expectancy

## Specification:

- Easy glide track, guaranteeing a smooth and effortless operation
- High security multi-point door lock
- 3\* high security cylinders as standard
- Made from solid Accoya, reliably trusted to not visibly swell, shrink or distort
- Available with a range of hardware options
- 1.2 whole door U value with double glazing
- 0.69 whole door U value with triple glazing

## Section details:

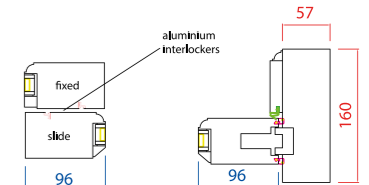
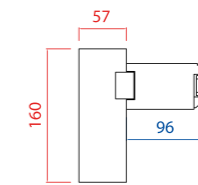
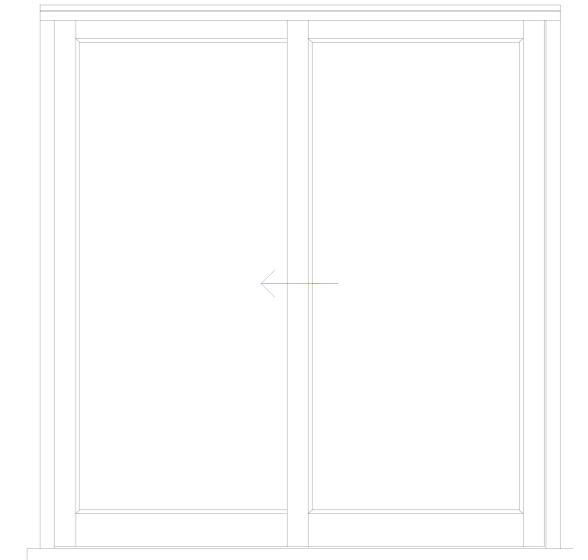
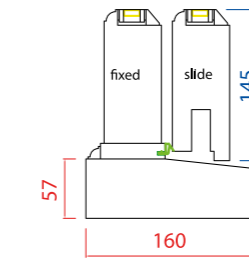
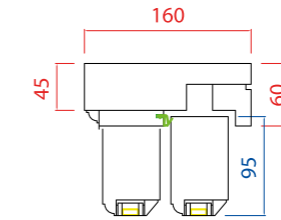

## Cill options:

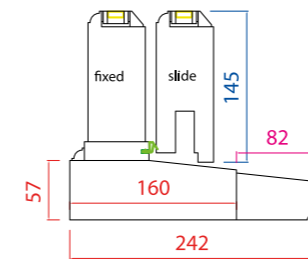
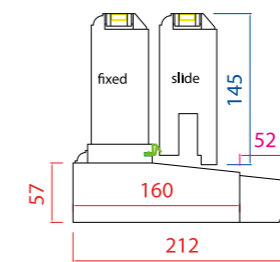
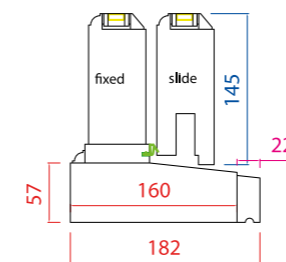

## Air vent in frame:

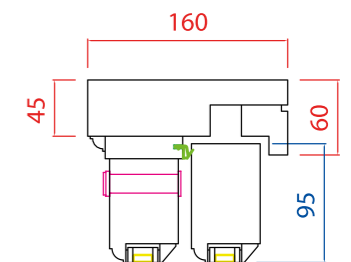

# Bi-folding door

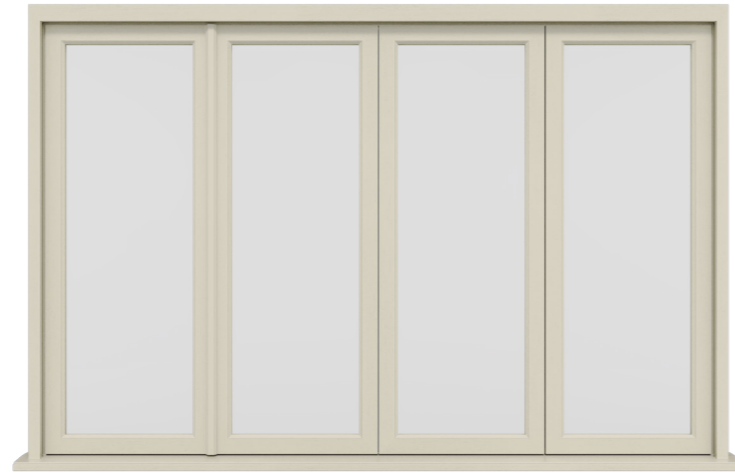

**1.2**  
W/km<sup>2</sup>K

Double Glazed  
U-Value

**0.74**  
W/km<sup>2</sup>K

Triple Glazed  
U-Value

## About:

Our high security bi-folding doors are available in a range of configurations, all operating effortlessly.

Using Maco multipoint door locks, Ultion 3\* door cylinders and solid Accoya, our Bi-folding doors are not only beautiful, but also safe and secure from unwanted intruders.

## Feature:

- Seamless corner joints, using twin mortice and tenon joints on all sash corners
- Flush-fit colour matching trickle vents, made from aluminium
- Three coat factory paint finish, dual colour available
- Vertically factory hung, ensuring perfect positioning and squareness
- Externally beaded for tradition, taped glass for high security
- Available with a large outerframe (20mm bigger) or a 20mm add on supplied separately
- Available in a range of configurations
- Crafted by experts
- 70+ year life expectancy

## Specification:

- High security multi-point door lock
- 3\* high security cylinders as standard
- Made from solid Accoya, reliably trusted to not visibly swell, shrink or distort
- Available with a range of hardware options
- 1.2 whole door U value with double glazing
- 0.69 whole door U value with triple glazing

## Section details:

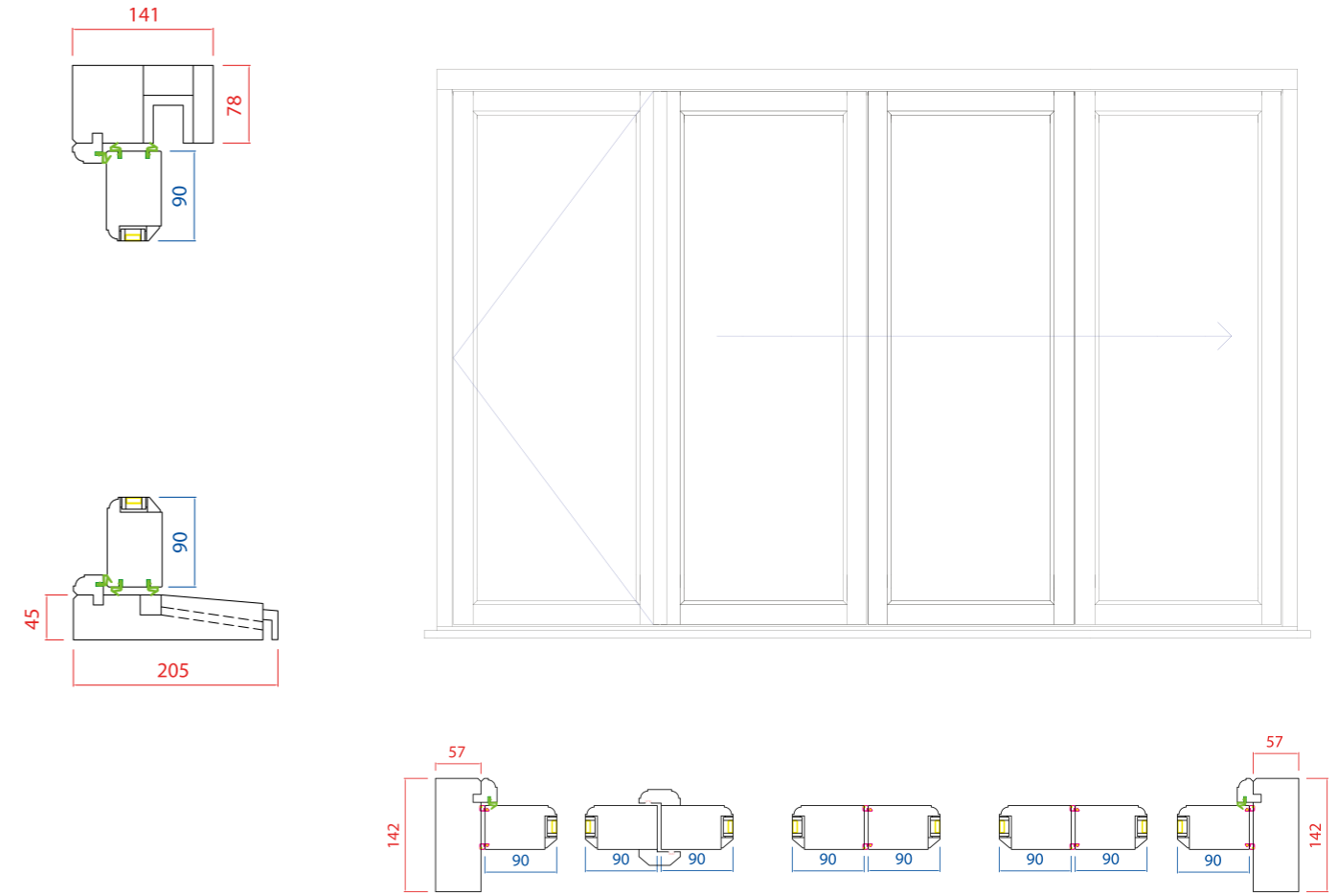

## Cill options:

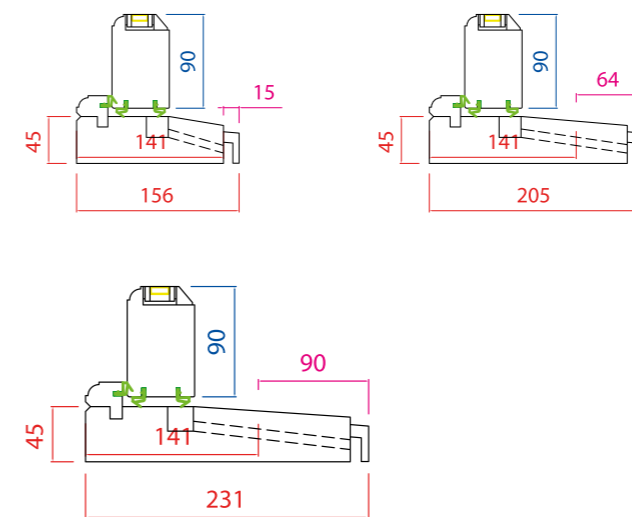

## Air vent in frame:

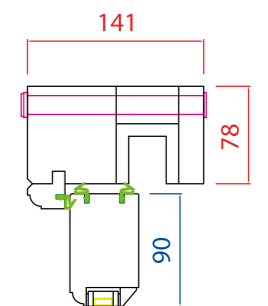

# Options & extras

## Glazing beads:

Splay  
(standard)

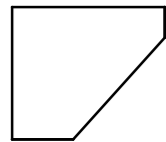

Ovolo

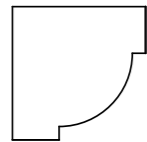

Cove

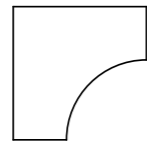

## Astragal surface bars:

For 24mm glazing:

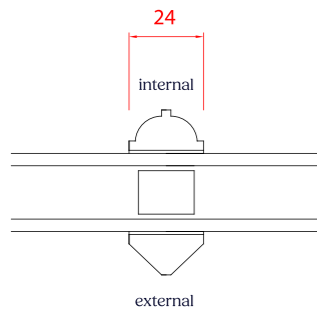

For 14mm slimline glazing:

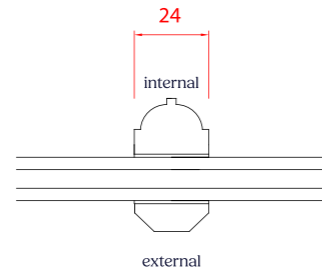

## Solid glazing bars:

For 24mm glazing:

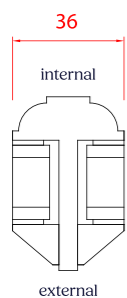

For 14mm slimline glazing:

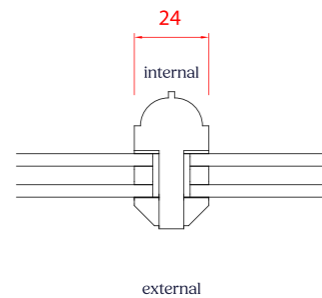

## Sash window horn styles:

Craftsman  
(standard)

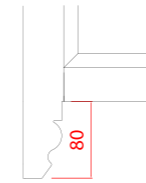

Heritage

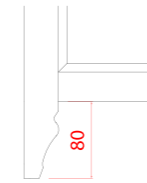

Crestline

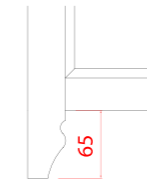

Artisan

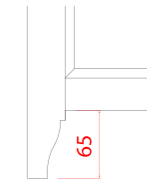

Ridgehorn

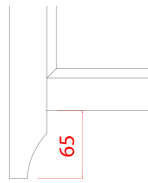

## Sash window external staff beads:

P-Shaped  
(standard)

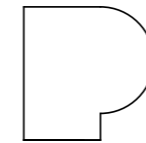

Ovolo

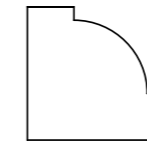

Cove

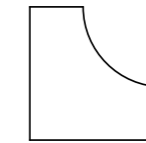

Bull Nose

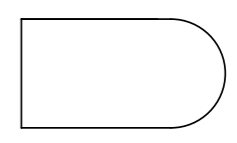

## Sash window internal linings:

P-Shaped  
(standard)



Ovolo



Cove



Square



# Tailored products

---

Whilst our Signature range covers most scenarios and accounts for around 80% of the frames we sell, we can also craft completely bespoke timber windows and doors, tailor made to exact requirements.

---

## Within our Tailored range, we can supply windows and doors that are:

- Made from a range of hardwoods in addition to Accoya
- Available with a stained finish, as well as a paint finish
- Arched, angled and shaped
- Ideal for conservation areas, where the exact shape and size of the frame and sash need to be matched
- Fitted with slimline windows, which are also popular in conservation areas -and sometimes essential to meet Conservation Officer's requirements
- Finished with bespoke hardware that the homeowner or architect has specified

---

For bespoke projects, our expert team are able to guide our customers through every step, providing detailed CAD drawings and technical support.















# Our customers

## Window installers

We help large and small window installation businesses across the UK to capitalise on the timber comeback.

Our Signature product range has been designed to make our beautiful hand-crafted products easy to understand, and we've built a catalogue of physical and digital sales tools that help installers to sell and grow.

Installers who fit our beautiful products stand-out from their local competitors, by offering materials that outperform and look better than uPVC and aluminium alternatives.

## Builders, contractors, developers and architects

We help house builders, contractors, developers and architects to build beautiful homes, or re-develop traditional properties with a deserved nod to their original heritage. Our Tailored product range allows us to cater for the exact shapes, sizes and specifications needed to fulfil whatever the project requires, however weird and wonderful those specifications may be.

Our team of experts can guide our trade customers seamlessly through the whole process, ensuring a beautiful project delivered smoothly, and on time.

## Builders' merchants, online distributors and trade counters

We help builders' merchants, online distributors and trade counters seamlessly supply our hand-crafted products to their onwards trade customers.

We understand this market thoroughly, and our distributor pricing level allows re-sellers to make an attractive margin on our 'easy-to-understand and sell' Signature product range.

A plethora of sales tools combined with great service and direct-to-site deliveries guarantee an effortless process that is exciting for any driven branch manager.

## When it comes to trade supply, 3 principles are engrained into our core.

### 1. Make the best hand-crafted windows and doors

Since 1985, we've been hand-crafting windows and doors with passion, precision and love, right here in the UK. Every seamless joint is made with the utmost care, and we dedicate time to ensuring each product is flawless before it leaves our workshop.

We source only the finest materials from trusted suppliers, which is why our windows and doors offer industry-leading thermal efficiency, with U-values as low as 0.68 W/m<sup>2</sup>K. With guarantees of up to 25 years and four decades of expertise behind us, we confidently stand by the quality of our products, offering a promise of excellence to all our trade customers.

### 2. Help our customers to sell and grow

We're dedicated to helping our trade customers win more business in an increasingly competitive market. That's why we've developed a suite of physical and digital sales tools designed to make it easier for our customers to close more deals.

Our products are straightforward, and we back them up with personalised service and technical support on every order, no matter the size. Our strict trade-only policy ensures that we never compete with our customers. When we generate homeowner leads, we pass them directly to our approved local installers. We're here to support your business, not compete.

### 3. Care for our planet

Caring for the environment is at the core of everything we do. That's why we hand-craft our windows and doors using fast-growing, sustainably sourced modified timber.

We carefully choose our raw materials and suppliers, and our factory is powered by timber offcuts, minimising waste. Every decision we make is guided by our commitment to the wellbeing of the planet.

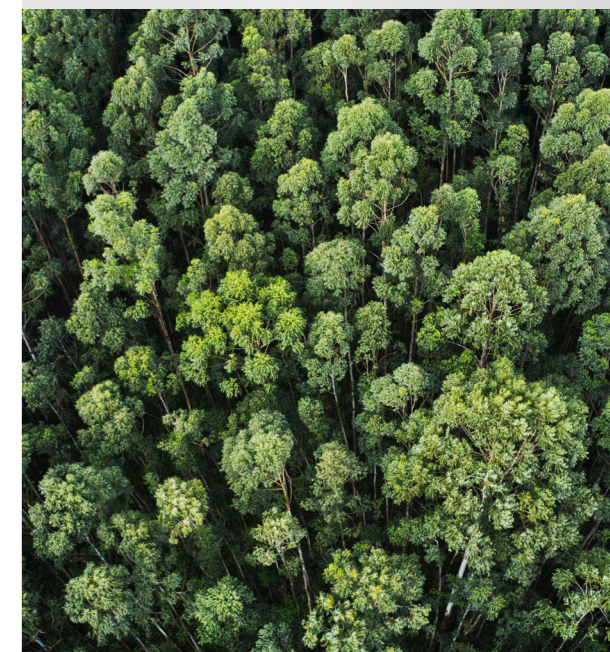
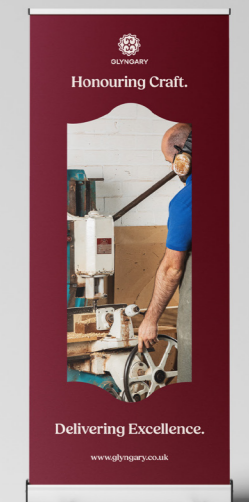

# Our process

## Quote

Send your desired sizes and specification to [sales@glyngary.co.uk](mailto:sales@glyngary.co.uk). We typically return quotes by email within 24 hours, in a clear and easy to understand PDF format.

With every quotation, we also send a link to our e-quote dashboard which allows you to add your mark-up, extras and logo before producing your own branded PDF quotation to send to your onward customer.



## Order

If you wish to go ahead with a quotation, simply sign and return it to us and we'll get things moving. We check the job carefully, before sending back an order confirmation advising your delivery period.



## Delivery

Once your job is approaching completion, we will contact you to discuss your delivery requirements. Our deliveries are done by our own people on our own transport ensuring your products are treated with the care they deserve.



# Help to sell and grow

We help our trade customers to win orders. It's a competitive market, so we've designed a suite of physical and digital sales tools that help our trade customers to sell more jobs.

As well as custom support, below are some of the tools that help our customers to display, promote and sell our hand-crafted windows and doors.



## Complete catalogue

**Quantity:** pack of 10

Our premium quality 152 page complete catalogue, suitable for trade & retail. It showcases everything about us, our products, our passion for greatness and how we operate.



## Colour collection

**Quantity:** pack of 3

Demonstrates some of our most popular colours painted onto real wooden sample blocks.



## Small sample frame

**Quantity:** 1

Small Accoya sample frame, the perfect size for the boot of a salespersons car. Available in flush, stormproof or sash.



## Window corner sample

**Quantity:** 1

Accoya window corner sample showing the frame and sash detail, and sealed glass unit. Available in flush, stormproof or sash.



## Large sample frame in movable stand

**Quantity:** 1

Large Accoya sample frame pre-installed into a portable display frame, perfect for premium showrooms. Available with flush, stormproof or sash.



## Door corner sample

**Quantity:** 1

Accoya entrance door corner sample showing the door and frame detail, including low threshold.



## Printed poster kit (x3)

**Quantity:** pack of 3

3 x printed high-resolution posters showcasing our craft and perfect for framing in showrooms.



## Printed postcard

**Quantity:** pack of 100

A5 postcards showcasing our products and craft. Perfect for letterboxes and handouts. Available printed with your brand and contact details.



## Digital assets pack

**Quantity:** 1

Access to all our digital assets, including photography, videography, logos and artwork.



## Roller banner

**Quantity:** 1

Printed high-resolution roller banner showcasing our craft and perfect for showrooms and exhibitions. Available in 3 designs.



## Hardwick hardware boards

**Quantity:** 1

Showroom hardware boards demonstrating the Hardwick range. Boards available for sash windows, entrance door accessories and door & casement handles.



## Professional site photoshoot

**Quantity:** 1

A professional site photoshoot of your beautiful installation, done by one of our partnered specialist photographers.

# Find an installer

We are a supplier to the trade, and we don't install windows and doors. However, if you don't already have someone lined up, we would be delighted to recommend a Glyngary approved installer to you.

We trust our approved installers to treat our hand-crafted products with the love and care they deserve, ensuring a beautiful installation completed professionally.

Contact us, and we can recommend someone who covers your area.



# Contact us:

## Website:

[www.glyngary.co.uk](http://www.glyngary.co.uk)

## Email:

[sales@glyngary.co.uk](mailto:sales@glyngary.co.uk)

## Telephone:

01925 763 836

## Socials:



## Address:

Unit E,  
Taylor Business Park  
Risley  
Warrington  
Cheshire  
WA3 6BL

 See our workshop in action





**GLYNGARY**

Unit E,  
Taylor Business Park  
Risley  
Warrington  
Cheshire  
WA3 6BL

Email: [sales@glyngary.co.uk](mailto:sales@glyngary.co.uk)  
Tel: 01925 763 836